

Cintiq[®] 12WX

Installation Guide & Hardware Manual
Model: DTZ-1200W



Wacom Cintiq® 12WX
Installation Guide & Hardware Manual
Version 2.0, Rev C2510
Copyright © Wacom Co., Ltd., 2010

All rights reserved. No part of this manual may be reproduced except for your express personal use. Wacom reserves the right to revise this publication without obligation to provide notification of such changes. Wacom does its best to provide current and accurate information in this manual. However, Wacom reserves the right to change any specifications and product configurations at its discretion, without prior notice and without obligation to include such changes in this manual.

The above year indicates when this manual was prepared. However, the date of release to the users of the “manual” is simultaneous with the introduction into the market of the applicable Wacom product.

DuoSwitch is a trademark, and Cintiq and Wacom are registered trademarks of Wacom Co., Ltd.

Adobe, Reader, and Photoshop are either registered trademarks or trademarks of Adobe Systems Incorporated in the United States and/or other countries. Microsoft, Windows, and Vista are either registered trademarks or trademarks of Microsoft Corporation in the United States and/or other countries. Apple, the Apple logo, and Macintosh are trademarks of Apple Computer, Inc., registered in the U.S. and other countries.

Any additional company and product names mentioned in this documentation may be trademarked and/or registered as trademarks. Mention of third-party products is for informational purposes only and constitutes neither an endorsement nor a recommendation. Wacom assumes no responsibility with regard to the performance or use of these products.

ExpressKey is a registered trademark of Ginsan Industries, Inc., and is used with permission.

INTRODUCTION AND OVERVIEW

The Wacom® Cintiq® 12WX interactive pen display combines the benefits of a Liquid Crystal Display (LCD) with the control, comfort, and productivity of Wacom's cordless, battery-free pen technology. This gives you a direct pen-on-screen interface for your computer.

The basic components of your Cintiq include a Wacom pen tablet internally mounted behind a TFT color display, and the Wacom Grip Pen.

Cintiq comes with an integrated display stand, enabling you to use the pen display flat on your desk or at an incline. Your pen display also includes a rotation pivot, enabling you to rotate the display as you work.

This manual describes how to install and use your Cintiq pen display.



- See “Your new Cintiq” on page 7 before unpacking or setting up the Cintiq pen display.
- To learn about the many features of your product, see “Cintiq pen display components” on page 8.
- Follow all instructions carefully when installing your product. See “Installation” on page 11.
- There are many ways to use Cintiq. See “Working with your Cintiq” on page 18 for details.
- Use the Wacom Tablet control panel to customize your pen and pen display settings. To learn more, see “Customizing” on page 27.

The following kinds of information are not included with this product: information about your specific computer hardware or operating system, or information about your application software. Your best source for this information is the set of manuals and discs that came with your hardware, operating system, or application.

Wacom's philosophy is to continually improve all of its products. As a result, engineering changes and improvements are made from time to time. Therefore, some changes, modifications, and improvements may not be covered in this document.

PRECAUTIONS

To ensure the safe usage of your product, be sure to follow all instructions, cautions, and warnings found within this manual. Failure to do so could cause the loss of data or damage to your computer. Failure to do so could also void your warranty, in which case Wacom shall have no responsibility to repair or replace the product.

-  Warning This symbol indicates an item that, if disregarded, may lead to loss of human life or serious injury.
-  Caution This symbol indicates an item that, if disregarded, may lead to human injury or damage to personal property.
-  Warning This symbol indicates an item that, if disregarded, may lead to loss of human life or serious injury.

Exercise due care and diligence whenever engaging in a described action.

PHYSICAL LOCATION

-  Warning The interactive pen display is solely applicable in normal office environments but may be used also as center consoles in climate controlled environments. The product was tested by Wacom for the usage in a normal office environment only and there was no particular inspection with regards to its compatibility in medical and military application areas. In addition, the interactive pen display is neither waterproofed nor explosion-resistant. It serves and can be used solely as a passive display and input device. In all applications that are not designated for its sole usage, no information on the functionality and possible malfunctions of the interactive pen display can be supplied due to inadequate execution of tests. The adoption of the interactive pen display in other application areas than normal office environments is at the user's risk.

ENVIRONMENT





Temperature and Humidity

- Operating temperature and humidity: 5° to 35°C, 20 to 80% RH
- Storage temperature and humidity: -10° to 60°C, 20 to 90% RH









-  Caution Do not use or store Cintiq where:
- Temperature changes are severe or exceed specifications (e.g., outdoors or inside a vehicle).
 - The pen display, the Grip Pen, and the converter unit are exposed to direct sunlight or heat from an appliance, or are exposed to water or any other kind of liquid.

-  Caution Do not use Cintiq in a dusty environment; this may damage the unit.

USAGE

-  Warning Only use the converter unit and power adapter that came with Cintiq. If a different type of converter or power adapter are used, Cintiq will not work properly or may be damaged. Using a different type of converter or power adapter also has the potential to result in fire. Use of a different converter or power adapter will void your warranty.
-  Caution Be sure to use a grounded power source when applying power to Cintiq.
-  Caution Do not connect or disconnect the video or power cables while Cintiq or your computer are turned on; this may damage the display, converter unit, or computer video card. In this case, Wacom shall have no responsibility to repair or replace the product.
-  Caution This product is for use with a DVI or VGA video card; using an inappropriate video card may damage Cintiq.
-  Caution Do not block the display panel or converter unit ventilation holes; this may overheat and damage the units.
- When not using Cintiq for long periods of time, unplug the power adapter from the AC outlet.

HANDLING

-  Warning High Voltage. Do not open or disassemble the Cintiq pen display or converter unit. There is a risk of electrical shock when the casings are open. This will also void your warranty and Wacom shall have no responsibility to repair or replace the product.
-  Warning If the LCD screen has been damaged, DO NOT touch any liquid that may be leaking from it; this liquid is an irritant. In case of contact with skin, eyes, or mouth, rinse immediately with running water for at least 15 minutes or more. If contact is made with the eyes or mouth, also consult a physician.
-  Warning  – LAMP(S) INSIDE THIS PRODUCT CONTAIN MERCURY AND MUST BE RECYCLED OR DISPOSED OF ACCORDING TO LOCAL, STATE OR FEDERAL LAWS.
- The Cintiq pen display has a backlight which contains mercury (Hg). Be sure to dispose of properly, and to manage any disposal of this unit in accordance with your local ordinances and laws.
-  Warning Choking hazard. Prevent children from swallowing the pen tip or side switch. The pen tip or side switch may accidentally be pulled out if children are biting on them.
-  Caution Do not disassemble the Grip Pen. This may cause the device to malfunction. In this case, Wacom shall have no responsibility to repair or replace the product.
-  Caution Do not scratch the display screen. Avoid placing sharp objects on the display screen surface.
-  Caution Avoid intensive shock or vibration to Cintiq, the converter unit, or the Grip Pen. Hitting or dropping Cintiq may damage the display screen or other components.

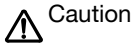

Caution

Do not put heavy articles on the pen display or push against it with a strong force; this may break the stand mechanism or damage the display screen. Do not overload the unit when the stand is open or the stand may break.

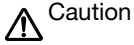

Caution

When opening or closing the stand, hold the stand carefully as you adjust it to prevent injury or damage to the product. Be careful to not let your fingers get caught in the moveable gap of the stand mechanism.

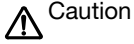

Caution

Do not place heavy articles on the Cintiq cabling, repeatedly bend the cables sharply, or apply heavy stress to the cable connectors; this may damage the unit or cabling.

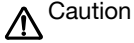

Caution

Do not excessively bend or crimp the cabling.

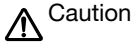

Caution

If the pen tip becomes sharp or angular, it may damage the coating on the display screen. Please replace the pen tip if necessary.

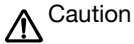

Caution

Do not use any organic solvent (e.g., alcohol) or even mild detergent to clean the display screen. Use of these cleaners can damage the coating on the screen. Damage of this kind is not covered by the manufacturer's warranty.

- To clean the display screen, use an anti-static cloth or a slightly damp cloth. When cleaning, apply only a light amount of pressure to the display screen and do not make the surface wet.
- To clean the Cintiq casing, converter unit, or Grip Pen, use a soft cloth with mild detergent (such as dish washing liquid) diluted with water.
- Before cleaning, always disconnect your product from the AC power source.

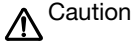

Caution

Do not expose Cintiq to high voltage electrostatic discharges or to a build-up of an electrostatic charge on the LCD screen. This may result in a temporary discoloration and blotching of the display. If discolorations occur, leave the display on and the discolorations should disappear within a few hours.

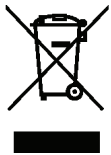

Reuse, recycling, and recovery. You are urged to recycle this product when replacing it with a newer product or when it has outlived its useful life by bringing it to an appropriate collection point for recyclable materials in your community or region. By doing this, you can help improve the environment of your community as well as minimize the potential negative effects created should any hazardous substance that may possibly be present within waste material reach the environment during the disposal process.

Within the European Union, users are required not to dispose of Waste Electrical and Electronic Equipment (WEEE) as unsorted municipal waste, according to the Directive 2002/96/EC of the European Parliament and of the Council of 27 January 2003, or the corresponding local laws of the Member States. Products for which this is applicable will be marked with the WEEE symbol shown at the beginning of this note unless this is not feasible because of the size or the function of the product. Wacom products are subject to the Directive 2002/96/EC and therefore you should always collect them separately and bring them to the appropriate collection point in your community or region.

Wacom pen display products comply with the European Union RoHS Directive 2002/95/EC (RoHS Directive).

CONTENTS

INTRODUCTION AND OVERVIEW	1
PRECAUTIONS	2
Physical location	2
Environment	2
Usage	3
Handling	3
YOUR NEW CINTIQ	7
Package contents	7
Cintiq pen display components	8
Front view	8
Rear view	9
Converter unit	10
INSTALLATION	11
System requirements	11
Step 1: display installation	12
Display cabling diagram	13
Step 2: pen tablet installation	16
USB cable installation	16
Software installation	17
WORKING WITH YOUR CINTIQ	18
Using the Grip Pen	18
Basic pen operations	19
Pen display controls	21
Using the ExpressKeys	22
Using the Touch Strips	23
Setting up your work area	24
Adjusting display incline	25
Rotating the tablet	26
Attaching the accessory feet	26
CUSTOMIZING	27
Opening the control panel	27
Learning more about Cintiq	27
Customization basics	28
Calibrating Cintiq	29
Adjusting clock and phase (VGA only)	30
Adjusting the display	31
Factory presets, auto-sync, and color calibration	31
On Screen Display (OSD) settings	32
Power saving	36

TROUBLESHOOTING37
Testing Cintiq37
Testing controls and input tools39
Testing the ExpressKeys39
Testing the Touch Strips39
Testing a pen40
Display troubleshooting41
General display problems41
VGA problems43
Pen tablet troubleshooting44
General problems44
Windows-specific problems48
Macintosh-specific problems49
Technical support options51
Obtaining driver downloads52
APPENDIX53
Caring for Cintiq53
Cleaning53
Replacing the pen tip54
Using a mounting fixture55
Pen and digital ink capabilities in Windows56
About the Windows Tablet PC Input Panel57
Uninstalling Cintiq58
Product specifications59
Cintiq 12WX (model DTZ-1200W) general specifications59
Display60
Pen tablet61
Converter unit61
Power adapter61
Grip Pen (model ZP-501E)61
Accessories62
Product information63
Ordering parts and accessories63
Radio and television interference64
Federal Communications Commission (FCC) notice64
Industry Canada (Canada only)65
CE declaration65
Warranty (Worldwide, Except for Europe, Africa and Middle East)66
Limited Warranty66
Warranty Service in the U.S.A. and Canada67
Warranty Service Outside of the U.S.A. and Canada67
Licence warranty conditions (Europe, Africa and Middle East)68
Software Licence Agreement68
Limited Warranty69
Cintiq exchange policy (Europe, Africa and Middle East)71

YOUR NEW CINTIQ

PACKAGE CONTENTS

Carefully unpack all items and place them on a desktop or stable work surface. Verify that your package contents are complete. To avoid damage, see the instructions on the following pages before setting up and using Cintiq.

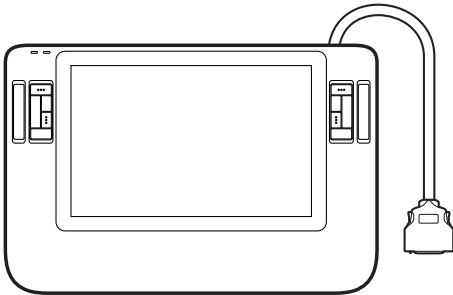

Cintiq 12WX (model DTZ-1200W) pen display with attached cable



USB cable (STJ-A258)

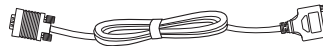

DVI-I to VGA cable (STJ-A259)

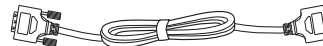

DVI cable (STJ-A260)

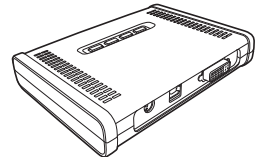

Converter unit (PLB-03)

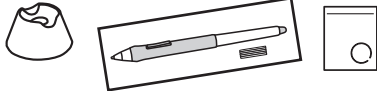

Grip Pen with replacement nibs, pen stand, and nib removal set (ZP-501E, PST-A034, and FUZ-A131)



Installation Guide & Hardware Manual (this manual)

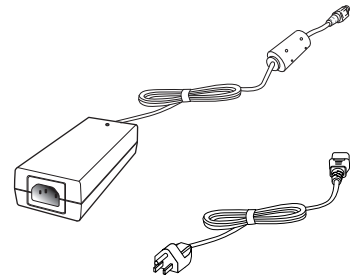

Power supply (POW-A102) and power cable



Wacom Pen Tablet Driver CD (contains the driver software)



Accessory set of 4 rubber feet (PAS-A063)

Note: Some configurations may include additional CDs or DVDs containing application software. To install these applications, review the instructions that came with those CDs or DVDs. Retain the package box for use when storing or shipping Cintiq.

CINTIQ PEN DISPLAY COMPONENTS

Your product has many features and components with which you will want to become familiar.

FRONT VIEW

The display and tablet sensor function as an integrated output and input device. The tablet sensor reports pen coordinates, pressure, tilt, switch, eraser, and other information.

Status LED

Lights blue when the pen is in the active area of the pen display and the pen tip, eraser, or side switch are pressed. The USB cable must be plugged into an active USB port and a video signal must be present before the LED will light.

Power LED

Lights blue when power has been supplied to Cintiq and a video signal is present.

Glows orange when no video signal is detected by Cintiq. (e.g., Your computer is turned off, starting up, or has entered a power management mode in which video signals are not sent.)

Touch Strip

Slide your finger over the Touch Strips to zoom, scroll, or perform custom keystroke actions. See "Pen display controls" on page 21.

ExpressKeys

All ExpressKeys can be customized to simulate modifier keys, keystrokes, and other frequently used functions. A Display Toggle function is also available, enabling you to toggle the screen cursor between the Cintiq pen display and your other displays. See page 21.

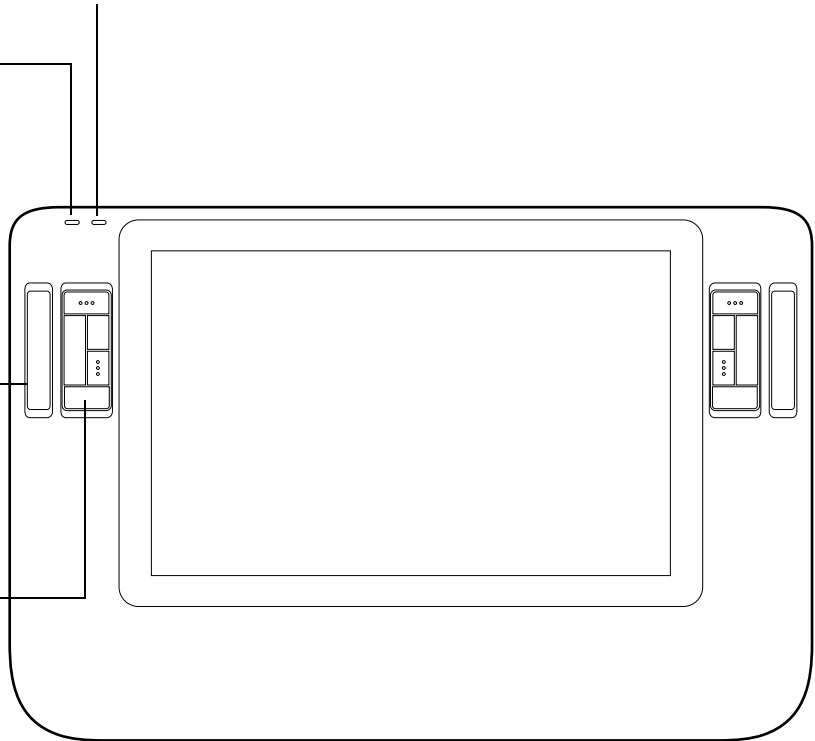

REAR VIEW

Rotation pivot

Allows rotating the Cintiq.
See "Rotating the tablet" on
page 26.

Security slot

Allows easy attachment of a security
cable. (Located on upper edge of unit.)

Integrated cable

Connects to the converter unit.
Carries all data, video, and power
signals to and from the pen display.

Pen tether attachment point

If using a pen tether, connect it
to the attachment point located
on either side of the unit.

Display stand

Enables you to you to adjust the incline of
the working surface. See "Adjusting
display incline" on page 25.

The unit can also be fixed to a VESA 75
standard mounting fixture. See "Using a
mounting fixture" on page 55.

Stand latch

Slide to the side to unlock the display
stand from the closed position.

Power switch

Turns power on or off.
(Located on upper edge
of unit.)

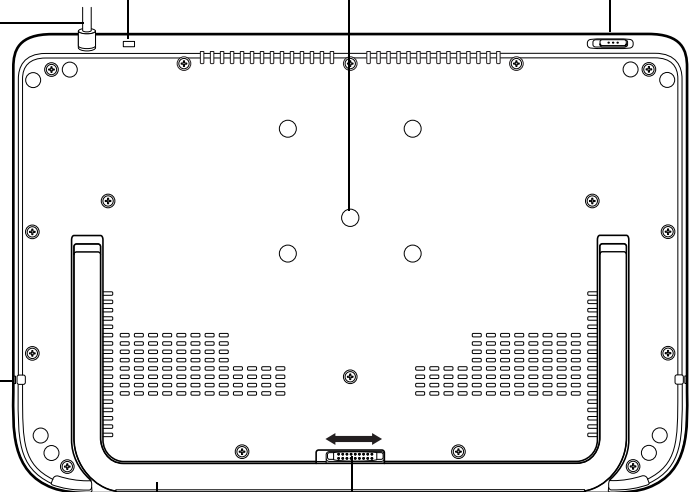

Important: Always store the pen display on a stable surface or in its original packing carton when not in use. Do not bend or crimp the cable.

CONVERTER UNIT

The converter unit provides an interface for all video and data signals passing between the Cintiq pen display and your computer. The unit also routes input power from the supply adapter to your pen display.

Power plug

For power input connection to the power supply adapter.

USB-A connector

For USB connection to your computer.

DVI-I video connector

Accepts an incoming DVI or VGA video signal from your computer.

On Screen Display (OSD) controls

Use these controls to adjust the display settings. See "Adjusting the display" on page 31.

Pen display cable connector

Connects to the pen display's integrated cable.

DVI/VGA (digital/analog) switch

Set this switch for the video connection you will be using.

For DVI, move switch left (toward the connector).

For VGA, move switch right.

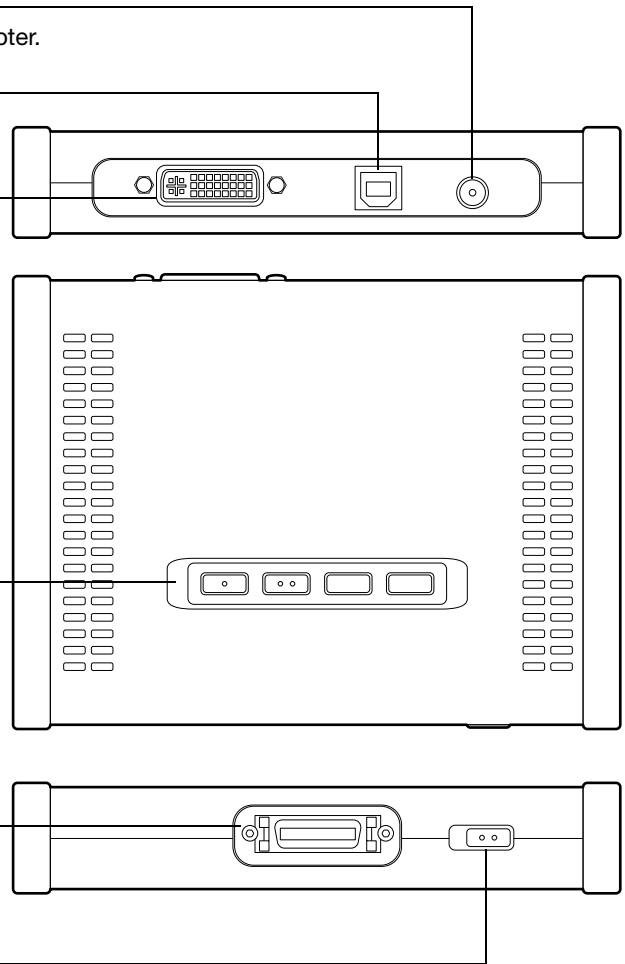

INSTALLATION

The computer treats the interactive pen display as two separate devices (the display and the pen tablet). Therefore, the installation process is completed in two stages:

- First install as a display.
- Then install as a pen tablet.

Both stages require hardware and software installations and adjustments. Carefully follow ALL instructions.

Important: You MUST install the Wacom driver software for correct pen-on-screen functionality.

SYSTEM REQUIREMENTS

Before installing Cintiq, be sure your computer meets the following minimum system requirements:

- PC. Windows 7, Vista™, XP (32 and 64 bit). DVI or VGA connector, available USB port, and CD-ROM drive.
- Macintosh. OS X, v10.4 or greater. DVI or VGA video connector, available USB port, and CD-ROM drive.

Cintiq supports both digital (DVI) and analog (VGA) video signals. If updating your video card, first complete the video card installation before connecting Cintiq. If you have another display that is compatible with your video card, you can use that display to verify the video card is operating correctly.

Although you can connect Cintiq to either a DVI or VGA video card, connecting to a DVI video card generally results in optimum performance.

Notes:

Cintiq can be used alone or with another display, such as a CRT monitor or LCD projector. To use Cintiq with another display, you will need two video cards or a video card with dual output.

Depending on the capabilities of your video card and operating system, you may be able to set up Cintiq as a mirrored, extended, or independent display. See your video card documentation for more information on its capabilities.

When working with more than one monitor, Cintiq will map to the monitors based upon how your system is configured. By default, if you are in mirror mode, the pen tablet will map to the entire space on each monitor. See your hardware and operating system documentation for details on configuring your computer and operating system for use with multiple monitors.

A Display Toggle function is available for use with multiple display systems. This enables you to toggle the screen cursor between Cintiq and your other displays. For more information, see “Using the ExpressKeys” on page 22.

STEP 1: DISPLAY INSTALLATION

In this step, Cintiq is installed as a display on your system.

Important: Never connect or disconnect the video or power cables while your computer or Cintiq are powered on. This can damage the display or video card.

1. Turn off your computer.
2. If your computer has only one video connector, you will need to unplug your previous monitor or add a second video card. Determine if your computer has a digital (DVI) or analog (VGA) connector, and set the DVI/VGA switch located on the converter unit for the video connection you are using. See – A – in the connection diagram on page 13.
3. Making sure to tighten the thumbscrews on the connectors, follow the instructions below for your video connector. See – B – in the connection diagram.

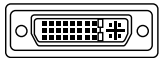

DVI-I connector

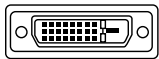

DVI-D connector

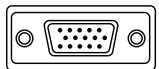

VGA connector

For DVI operation, connect the Cintiq video cable between the DVI-I connector located on the converter unit and the DVI-D or DVI-I connector on your video card.

For VGA operation, connect the Cintiq video cable between the DVI-I connector located on the converter unit and the VGA connector on your video card.

If connecting to a Mac Mini DisplayPort, you will need to obtain an appropriate adapter. For best results the Apple Mini DisplayPort to Dual-Link DVI Adapter is recommended. Adapters can be purchased at various retail outlets and through the online Apple Store.

Connect the adapter between the Cintiq video cable and your Macintosh.

4. Plug the pen display's integrated cable into the matching connector on the converter unit. When fully seated, the connector will snap into place. See – C – on the next page.
5. Connect the power adapter to the converter unit. Then connect the adapter's power cable and plug the adapter into an AC outlet. See – D – and – E – in the connection diagram.
6. Turn on Cintiq. The power LED will light orange.

DISPLAY CABLING DIAGRAM

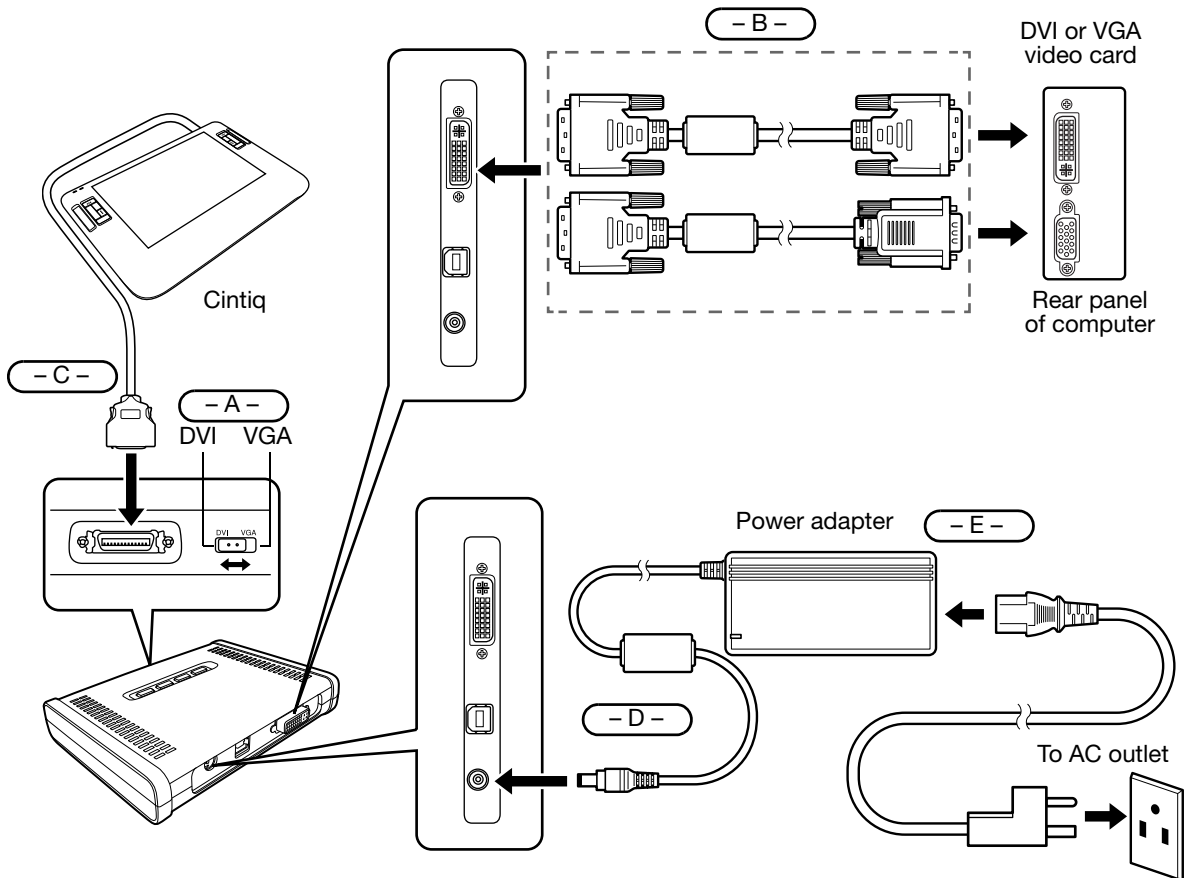

Caution

Make sure your video card has a DVI or VGA connector, and that you correctly set the Cintiq DVI/VGA switch for the video connection you are using.

Use only the converter unit and power adapter that came with Cintiq; use of an improper converter or power adapter may damage the unit.

Do not connect or disconnect the video or power cables while Cintiq or your computer are turned on – this can damage the display or computer video card.

Make sure that the display refresh rate does not exceed the maximum vertical frequency that Cintiq can support. See “Product specifications” on page 59 for details.

7. Next, turn on your computer.

For Windows: Cintiq will automatically install as a default monitor. To identify the unit as a pen display and install the color calibration profile:

A) Open the CONTROL PANEL folder.

- For Windows 7 and Vista, under APPEARANCE AND PERSONALIZATION select ADJUST SCREEN RESOLUTION.
- For Windows XP, open the DISPLAY PROPERTIES control panel and select the SETTINGS tab.

If you have more than one monitor, click IDENTIFY MONITORS to determine which display corresponds to the pen display. Select the number corresponding to Cintiq.

B) Click ADVANCED SETTINGS....

C) Select the MONITOR tab and click PROPERTIES.

D) Select the DRIVER tab and click UPDATE DRIVER.... An update driver dialog or Wizard will appear.

E) Insert the Wacom Pen Tablet Driver CD. If the Wacom Tablet installation menu displays, close it.

Windows 7 and Vista:

- Select BROWSE MY COMPUTER FOR DRIVER SOFTWARE.
- Enter the drive letter for the Wacom Pen Tablet Driver CD and click NEXT.
- After the installation is complete, close any open control panel windows.

Windows XP:

- The Wizard will ask if Windows can search for software. Choose NO, NOT THIS TIME and click NEXT.
- Select INSTALL FROM A LIST OR SPECIFIC LOCATION (ADVANCED), and click NEXT.
- Select DON'T SEARCH. I WILL CHOOSE THE DRIVER TO INSTALL, and click NEXT.
- Select the pen display option and click HAVE DISK.... Enter the letter of your CD-ROM drive (e.g., E:\), and click OK.
- Follow the prompts. (If the HARDWARE INSTALLATION dialog box displays, click CONTINUE ANYWAY.) After installation is complete, click FINISH and close any open control panel windows.

For Macintosh, a color profile is added to your color management system during the driver software installation process. To activate this color profile for use with Cintiq, you may need to select the Cintiq profile in the system's ColorSync Utility control panel. For details, see the color management information in your operating system and application documentation.

8. As necessary, configure the display control panel settings for the proper size and color resolution. See the “Product specifications” on page 59 for details about the maximum (native) resolution and other resolution sizes that can be used with Cintiq. The display size and color resolution may be constrained by the capabilities of your video card.

Windows: If you are using Cintiq as a secondary display, you may first need to enable Cintiq in your display properties control panel.

To fine-tune the display, see “Adjusting the display” on page 31. If using analog (VGA) mode, see “Adjusting clock and phase (VGA only)” on page 30.

9. After the LCD monitor portion of the installation is working to your satisfaction, move on to Step 2: pen tablet installation.

For troubleshooting tips, see “Troubleshooting” on page 37.

Notes:

If your graphics card does not support the Cintiq’s native resolution of 1280 x 800 pixels, check with your graphics card manufacturer for a driver update.

Each Cintiq LCD panel is produced under stringent quality standards. Production techniques cannot guarantee an absolutely perfect display, and some panels may exhibit a certain number of pixels that show an incorrect color. See the “Product specifications” on page 59 for more information.

If an image has fine striping (such as screen stripes), it may appear to flicker or display a moiré pattern.

Do not apply excessive pressure on the display screen surface, it may cause the appearance of a moiré or pooling pattern. If this occurs, use less pressure on the display screen when working with the pen.

When a still image is displayed for a long period of time, an after-image may remain for a short time. To prevent this, use a screen saver or other power management feature.

To extend the life of the pen display backlight, set your computer’s power management to turn off the display when it is not in use for extended periods of time.

STEP 2: PEN TABLET INSTALLATION

In this step, Cintiq is installed as a pen tablet.

USB CABLE INSTALLATION

1. First plug the USB cable into the USB connector located on the converter unit.
2. Plug the other end of the cable into an available USB port on your computer or into a USB hub.

Next, install the pen tablet software. See “Software installation” on page 17.

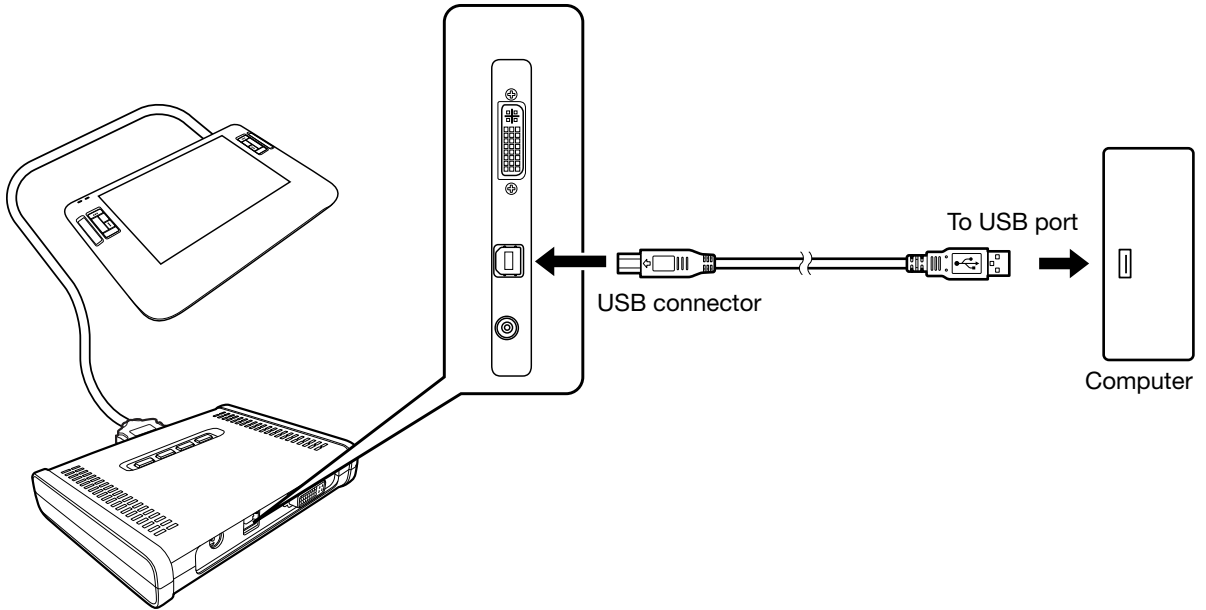

SOFTWARE INSTALLATION

Important: You MUST install the Wacom pen tablet driver software for correct pen-on-screen functionality.

Save your work and close all open applications. Temporarily disable any virus protection programs.

- Insert the Wacom Pen Tablet Driver CD into your computer's CD-ROM drive. If the software installer menu does not automatically display, double-click on the INSTALL icon located on the CD.
- Click INSTALL TABLET and follow the prompts to install the driver software.
- Reactivate your virus protection program.
- After completing the software installation, make sure you can use your pen on the Cintiq display screen to move the screen cursor.

When you place the pen tip on the display screen, the screen cursor should immediately jump to a corresponding position approximately beneath the pen tip. Lift the pen tip and place it on the display screen surface in a different location. The screen cursor should again jump to the new position. This is known as absolute positioning, and enables you to position the screen cursor without having to drag your pen across the display screen surface.

- Be sure to check the Read Me file for updated information. If you have trouble installing Cintiq, see "Troubleshooting" on page 37.

Notes:

Driver installation automatically activates the new pen input functions available within Microsoft Windows 7, Vista, and Office 2007 or later (except for Windows 7 Starter and Home Basic, and Windows Vista Home Basic). Visit the Wacom web site at www.wacom.com/vista for additional information on using your Wacom pen in Windows.

User-specific preferences are supported. After logging in, each user can customize their personal settings in the Wacom Tablet control panel. Switching to another user will automatically load the settings for that user.

If the pen display does not respond properly or you lose cursor control, the pen display preferences may be corrupted. You can delete the current preference settings and return the pen display to its factory default condition. See the Software User's Manual for details on managing preferences.

To uninstall the software driver, see "Uninstalling Cintiq" on page 58.

Next, see "Calibrating Cintiq" on page 29 to precisely align the screen cursor to the pen tip.

WORKING WITH YOUR CINTIQ

USING THE GRIP PEN

The pen is cordless, battery-free, and sensitive to the tilt and pressure you exert upon it. Hold the Grip Pen as you would a normal pen or pencil. As you work, you can rest your hand lightly on the Cintiq display screen, just as if it were a drawing board or sheet of paper. You can tilt the pen in any way that feels most comfortable for drawing.

DuoSwitch (side switch): Make sure the programmable switch is in a convenient location where you can toggle it with your thumb or forefinger, but not accidentally press it while drawing. You can use the switch whenever the pen tip is within 5 mm (0.2 inch) of the tablet surface; you do not need to touch the pen tip to the tablet. Toggle the switch in either direction to activate the button functions. By default, the upper switch is set to DOUBLE CLICK and the lower switch is set to RIGHT CLICK.

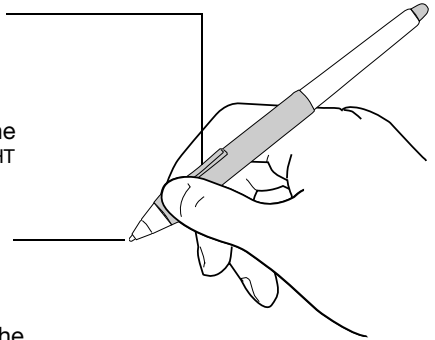

Pen tip (replaceable nib): The pen is activated as soon as it is brought within 5 mm (0.2 inch) of the pen display screen. This allows you to position the screen cursor without touching the pen tip to the display screen. When pressure is applied to the pen tip, the pen simulates a primary mouse button click. The tip click pressure can be adjusted in the Wacom Tablet control panel. By default, the tip function is set to CLICK.

Eraser: When the eraser is brought within 5 mm (0.2 inch) of the display the tablet reports the pen location. Pressure information is reported as you press down on the eraser. By default, the eraser function is set to ERASE.

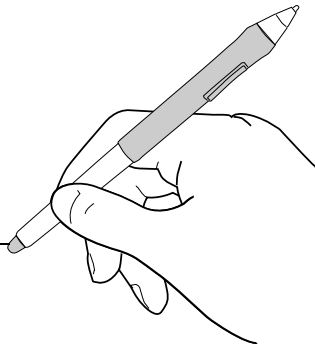

When the Grip Pen is not in use, place it in the pen stand or lay it flat on your desk.

To maintain the sensitivity of your pen, do not store the pen in a container where it will rest on its tip or eraser.

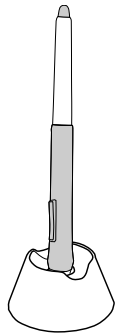

Important: Only use a pen that is compatible with Cintiq, such as the pen that shipped with the unit or any of the pens from the Intuos3 product line (see “Accessories” on page 62). Other pens may not function properly. Also, the Cintiq pen tip is specifically designed for use with the Cintiq pen display – the tips on other pens could damage the protective coating on the display screen.

For information on customizing the pen settings, see “Customizing” on page 27.

BASIC PEN OPERATIONS



Positioning: To position the screen cursor, move the pen slightly above the Cintiq display screen without touching the screen surface. Press the pen tip on the display screen to make a selection.

Note: You must calibrate the pen display to correctly align the screen cursor with the pen tip. (See “Calibrating Cintiq” on page 29.) If the screen cursor does not jump to a position close to the pen tip when you place the pen on the display screen, then the pen display software driver may not be installed or is not loading. Install the driver software if necessary. Otherwise, see “Troubleshooting” on page 37.



Clicking: Tap the display screen once with the pen tip, or touch the pen to the display screen with enough pressure to register a click.

Tip: You can make navigating with the pen easier by configuring Windows to select when the pen is over an icon and to launch the icon with a single click. To turn on this feature, first open a folder.

For Windows 7 and Vista, from the ORGANIZE pull-down menu choose FOLDER AND SEARCH OPTIONS. From the GENERAL tab select SINGLE-CLICK TO OPEN AN ITEM (POINT TO SELECT).

For Windows XP, from the TOOLS pull-down menu choose FOLDER OPTIONS.... From the GENERAL tab select SINGLE-CLICK TO OPEN AN ITEM (POINT TO SELECT).



Double-clicking: Press the upper side switch, or quickly tap the display screen twice in the same place with the pen tip. Double-clicking is easier when the pen is perpendicular to the tablet screen. See the electronic Software User’s Manual for information on fine-tuning the double-click area.

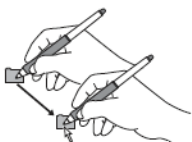

Dragging: Select an object, then slide the pen tip across the display screen to move the object.

Using the side switch: The pen is equipped with a DuoSwitch. This switch has two programmable functions that can be selected by rocking the switch in either direction. You can use the DuoSwitch whenever the pen tip is within 5 mm (0.2 inch) of the tablet surface; you do not need to touch the pen tip to the tablet in order to use the switch. By default, the upper switch is set to DOUBLE CLICK and the lower switch is set to RIGHT CLICK. Switch functions can be modified or disabled using the Wacom Tablet control panel. See the electronic Software User's Manual for details.

Drawing with pressure sensitivity: The pen responds to the nuance and inflection of your hand movements, enabling you to create natural-looking pen and brush strokes within applications that support this feature. To draw with pressure, select a pressure-sensitive tool from your application's tool palette. As you draw on the screen surface, use various amounts of downward pressure on the tip of the pen. Press lightly for thin lines or softer color. Press harder for thick lines or dense color.

Drawing with tilt: The pen display recognizes when you tilt the pen from vertical to incline positions. In supporting applications, tilt can be used to control line shape and thickness.



Erasing: In supporting applications, the pen's eraser works like the eraser on a pencil. In text applications, use the eraser to select text, then lift the eraser from the pen display screen to delete the text.

PEN DISPLAY CONTROLS

The customizable ExpressKeys and Touch Strips enable you to improve your workflow in graphics or other applications. While using the pen with your dominant hand, you can simultaneously use your other hand to operate the ExpressKeys or Touch Strip.

Touch Strip

Slide your finger up or down to zoom, scroll, or issue an assigned keystroke function. See “Using the Touch Strips” on page 23.

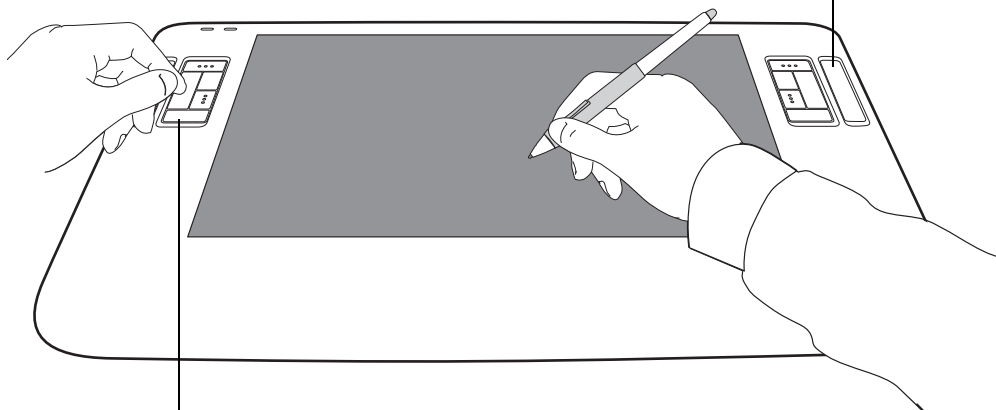

ExpressKeys

Press the keys to quickly change tool properties, or perform frequently used functions or keystrokes. By default, the ExpressKeys emulate keyboard modifier keys. See “Using the ExpressKeys” on page 22.

A Display Toggle function is also available for use on multiple display systems. This feature allows you to use your pen on the Cintiq pen display to navigate the screen cursor to any display on your system. See the electronic Software User’s Manual for details on working with Display Toggle.

USING THE EXPRESSKEYS

As you work with your pen on the display surface, press an ExpressKey to toggle between tools or change tool properties. You can work with the default settings, or choose from any of the other available functions. The default settings were chosen to optimize your workflow in Photoshop and other graphics applications using the following modifier functions:

Button 1: CTRL modifier key for Windows. COMMAND (Apple key) for Macintosh.

Button 2: SHIFT modifier key.

Button 3: ALT modifier key for Windows. OPTION modifier key for Macintosh.

Button 4: PAN/SCROLL function.

Button 5: DISPLAY TOGGLE. Available only on multiple display systems.

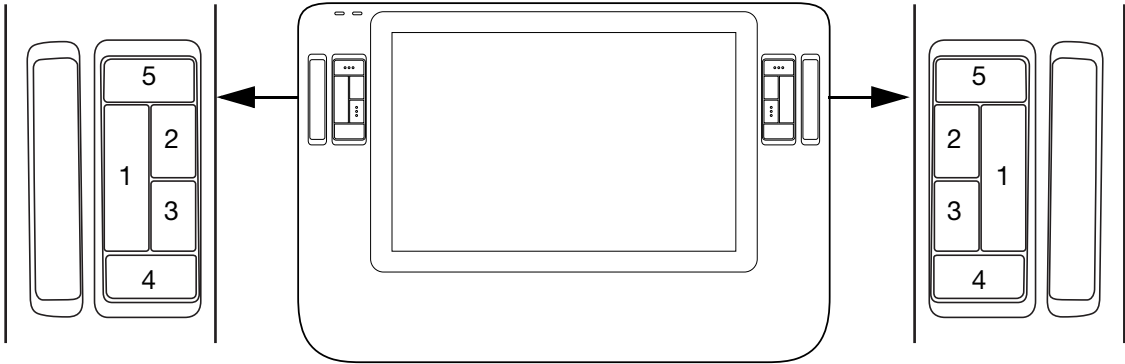

The ExpressKeys are chordable. For example, pressing keys 1 and 3 together simulates CTRL+ALT in Windows, or COMMAND+OPTION on Macintosh systems.

Tips:

On multiple display systems only, set an ExpressKey or pen switch to DISPLAY TOGGLE. You can then press that button to toggle the screen cursor between Cintiq and your other displays.

Press button 4 on your pen display to use the pen to pan (move) the image within the active application window.

In Photoshop and many other graphics applications, the ALT, CTRL, and SHIFT modifier keys modify a tool or switch to a complementary tool while the modifier key is pressed.

Set a pair of keys to commonly used keystrokes, such as [and] to decrease and increase your brush size in Photoshop.

Set a key to a commonly used keyboard shortcut, or to open files or start an application.

If you prefer not to (or cannot) use the side switches on your Grip Pen, then set a key to right- or double-click.

See the electronic Software User's Manual for details on the available key settings.

Important: Some applications can override and control the ExpressKey functions. For details, see the section on using applications integrated for tablet control in the Software User's Manual.

USING THE TOUCH STRIPS

The customizable Touch Strips can be operated in several different ways:

- **Standard operation:** Slide your finger up or down to zoom, scroll, or issue the assigned function. You can do this with your secondary hand while using your primary hand to work with the Grip Pen.

By default, the Touch Strips enable you to zoom in most graphics applications and to scroll in other applications.

Each Touch Strip can be set to issue custom keystrokes.

Tip: Photoshop users who frequently change brush sizes may want to assign the [and] keys to a Touch Strip. Sliding your finger up or down the Touch Strip will then change the brush size without the need to reach for the keyboard or access the Photoshop Brushes palette.

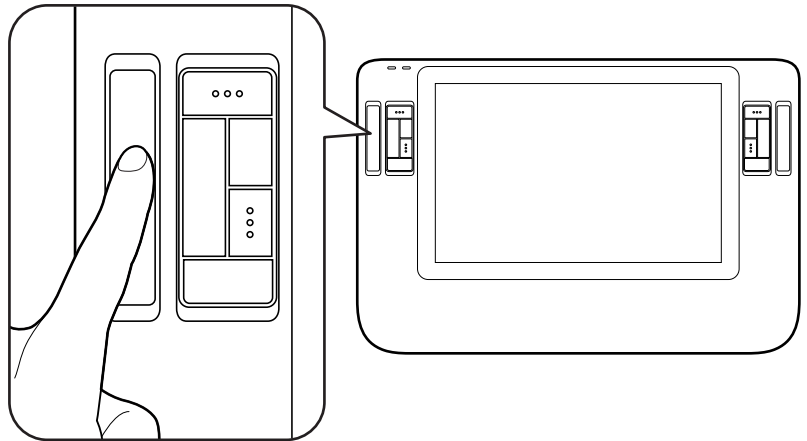

- **Single step operation:** Press and release your finger on either end of the Touch Strip to zoom, scroll, or issue the assigned keystroke function one step at a time.

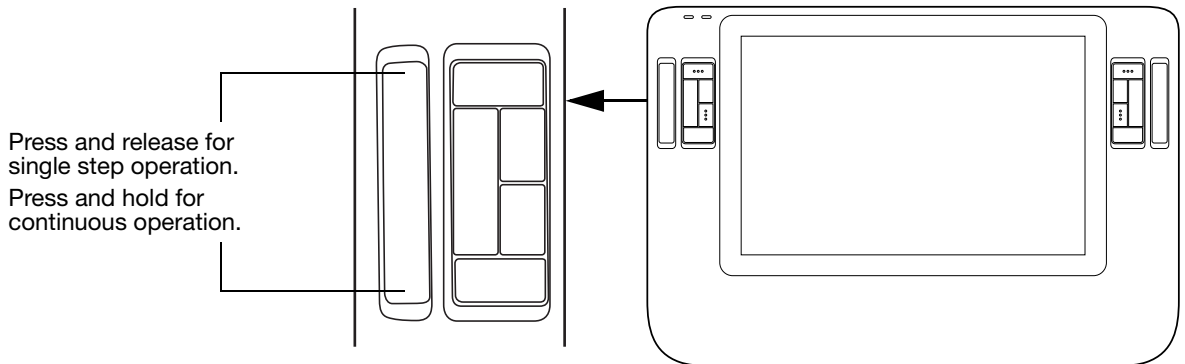

Press and release for single step operation.

Press and hold for continuous operation.

- **Continuous operation:** Press and hold your finger on either end of the Touch Strip to continuously scroll. This is useful for scrolling through long documents or web pages.

See the electronic Software User's Manual for detailed information on customizing the Touch Strips.

SETTING UP YOUR WORK AREA

To minimize fatigue, organize your work area so you can work comfortably. Position Cintiq, the Grip Pen, and your keyboard so they are easily accessible without unnecessary reaching. The pen display and any other displays should be positioned so you can view them comfortably with a minimum of eyestrain.

You may want to experiment with the rotation pivot and the different Cintiq stand height adjustments to determine what best fits your particular working style and tasks.

Here are some other points to keep in mind:

- Take short breaks between tasks to stretch and relax your muscles.
- Use a gentle grip when working with the pen.
- Alternate tasks throughout the day.
- Maintain a good posture at all times. Minimize awkward postures and repetitive movements that cause discomfort. Change your position if you feel any discomfort due to your work position.
- Alternate between different modes of use.

Note regarding RSI: Wacom makes no representation, promise or guarantee that Wacom products will cure or prevent, in whole or in part, mouse-induced repetitive stress symptoms, injuries or conditions. Individual results may vary. Always obtain competent medical advice to determine the most appropriate treatment for your specific situation.

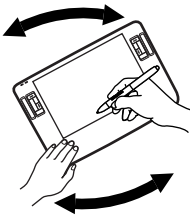

When the stand is closed, the pen display unit can be freely rotated on the pivot, just like a sheet of paper. This provides you with the freedom to adjust the display unit for the greatest comfort and accuracy of stroke while drawing or editing.



Fully open the stand when you want to work with Cintiq at a fixed incline. You may also find this a comfortable setting for working with Cintiq in a hand-held or lap position.



Adjust the stand to its middle position for a more vertical view of the display screen. This position is common when your work requires a large amount of keyboard input and when presenting your work to co-workers or clients.

Tips:

Do not pull the cable out of its connection by accidentally moving the pen display too far from the converter unit or computer.

Consider using an optional pen tether to ensure your pen stays with your pen display.

Cintiq can also be mounted to articulated arms or other third-party stands meeting the VESA 75 specification for display stands. For details, see “Using a mounting fixture” on page 55.

ADJUSTING DISPLAY INCLINE

- To open the display stand, locate and slide the stand latch to release the stand. Unfold the stand from the pen display casing.
- To close the stand, gently fold the stand back into the closed position until the latch catches the stand.

When using the integrated display stand, make sure that it is opened wide enough to prevent the Cintiq from tipping over.

Cushion

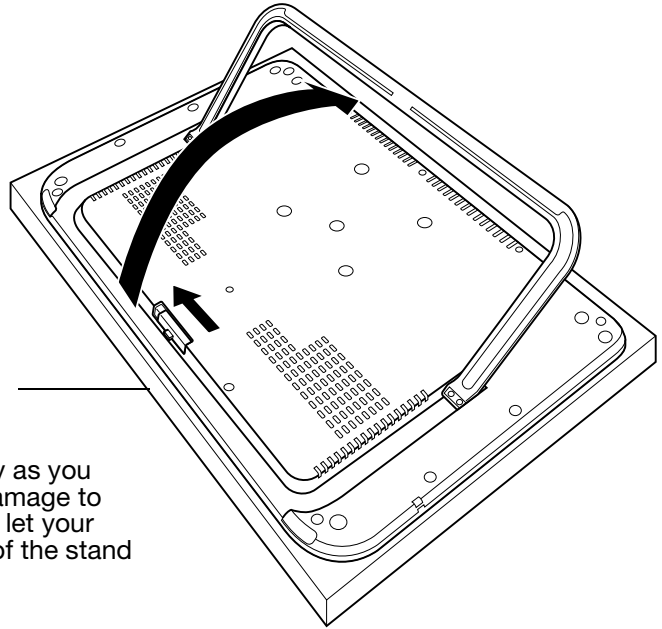

Caution Please hold the stand carefully as you adjust it to prevent injury or damage to the product. Be careful to not let your fingers get caught in the gap of the stand mechanism.

ROTATING THE TABLET

When the pen display stand is in the closed position, the unit can be rotated. As you work, position Cintiq by the main body; it will move on the rotation pivot.

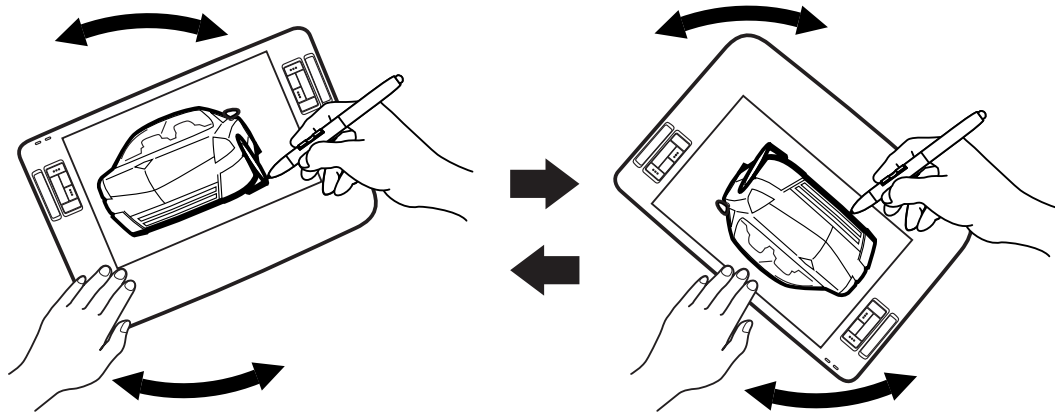

ATTACHING THE ACCESSORY FEET

If you do not want to use the rotation pivot, you can install the optional rubber feet that came with your product at any time. Simply remove the adhesive backing and attach each foot in a positioning depression (located near each felt foot pad).

Note: Once installed, the accessory feet cannot be removed

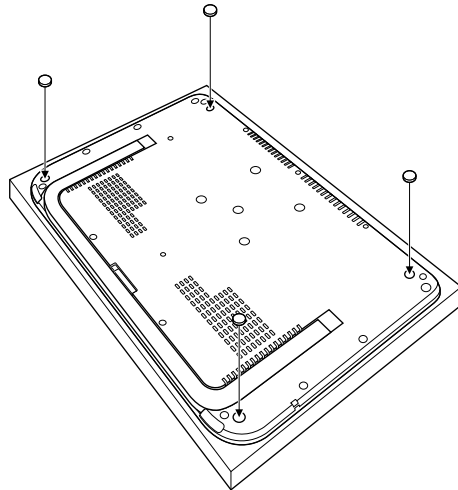

CUSTOMIZING

After you master the basics of using your Grip Pen on the Cintiq pen display, you may want to customize the way the pen or pen display works. The Wacom Tablet control panel makes it easy to customize Cintiq and the pen.

OPENING THE CONTROL PANEL

To open the control panel, use the Cintiq pen on the pen display:

Windows. Click on the Windows START button and choose ALL PROGRAMS. Then select WACOM TABLET and choose the WACOM TABLET PROPERTIES option.

Macintosh. Open SYSTEM PREFERENCES from either the Dock, the Apple menu, or from the APPLICATIONS folder. Then click on the WACOM TABLET icon.

You can begin customizing the pen display after opening the control panel. See “Customization basics” on page 28.

Note: User-specific preferences are supported. After logging in, each user can customize their personal settings in the Wacom Tablet control panel. Switching to another user will automatically load the settings for that user.

LEARNING MORE ABOUT CINTIQ

See the electronic Software User’s Manual for detailed information on customizing Cintiq.

To view the manual, open the Wacom Tablet control panel and click on the HELP button.

To read the Software User’s Manual before installing Cintiq, first insert the Wacom Pen Tablet Driver CD into your computer’s CD-ROM drive. When the software menu appears, select the USER’S MANUAL option.

You will need Adobe Reader or another .pdf viewer to view the manual.

CUSTOMIZATION BASICS

This manual describes only the basics of customizing Cintiq. For detailed information see the Software User's Manual.

Open the Wacom Tablet control panel to customize your product. When you open the control panel, an icon for the GRIP PEN is displayed in the TOOL list and the appropriate tabs are displayed. To customize the pen, make changes to the tab controls. Experiment with different settings to find what works best for you. Any changes you make will take effect immediately, but you can always click DEFAULT to return to the factory settings.

Note: Application-specific settings are for advanced users. This topic is covered in the Software User's Manual.

The upper portion of the control panel displays icons representing your pen display (TABLET), TOOL, and APPLICATION settings.

Closes the control panel.

Tabs display customizable settings for the selected TOOL.

Choose FUNCTIONS to customize your ExpressKeys, Touch Strips, and Radial Menu settings.

Choose GRIP PEN to customize your pen settings.

Displays an information dialog, including an option to access the DIAGNOSTICS dialog.

Resets the selected tab to its default settings.

Displays advanced options.

Displays the Software User's Manual.

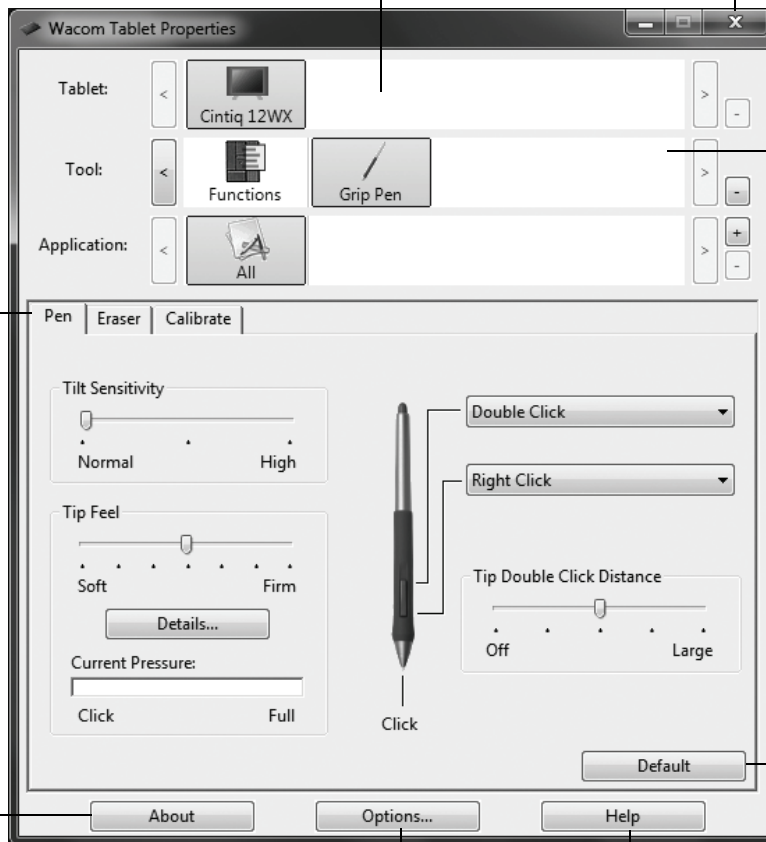

CALIBRATING CINTIQ

You must calibrate the pen display in order to align the screen cursor with the position of the pen on the display screen. This is required to compensate for viewing angle, and to adjust for parallax caused by the display screen cover glass and coating. Set Cintiq in its working position, then follow the procedure below.

Important: When using a VGA connection, make sure the Cintiq is properly adjusted before calibrating the tablet. See “Adjusting the display” on page 31 and “Adjusting clock and phase (VGA only)” on page 30.

1. Open the Wacom Tablet control panel.
If more than one pen display is installed on your system, select the unit your are working with from the TABLET list.
2. Select GRIP PEN from the TOOL list and then select the CALIBRATE tab.
3. If you are working with multiple monitors, select the MONITOR corresponding to the Cintiq display. (Only monitors that are set to one of the resolutions supported by Cintiq will appear in the list.)
4. Click on the CALIBRATE... button to activate the calibration screen.
5. Hold the pen and position your head as you normally do when working with the pen display. Use the pen tip to click on the center of the crosshairs in the upper-left corner.
6. Then click on the center of the crosshairs that are displayed in the lower-right corner.
7. Test the alignment by positioning the pen at a few different points on the display. Click OK to accept the calibration. Click TRY AGAIN to recalibrate.

Note: Be sure to read the directions in the calibration screen for detailed instructions and additional options. The calibration setting applies to all applications.

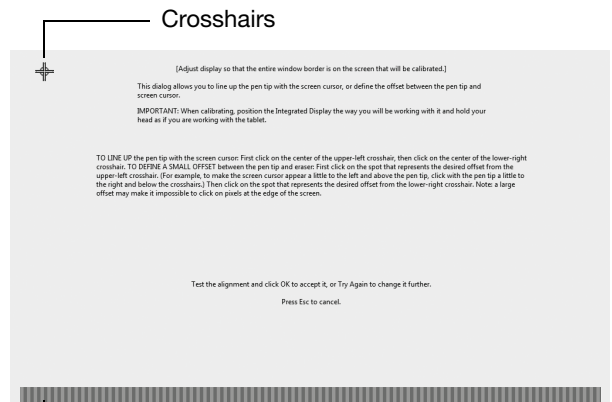

Adjustment pattern for clock and phase. For details, see “Adjusting clock and phase (VGA only)” on page 30.

Tip: If you prefer to see the screen cursor slightly offset from the actual position of the pen tip, calibrate by clicking on a spot showing that offset from the crosshairs. For example, to have the screen cursor appear 2.5 mm (1/10th of an inch) above and to the left of the pen tip, calibrate by clicking on a spot 2.5 mm (1/10th of an inch) below and to the right of the crosshairs.

ADJUSTING CLOCK AND PHASE (VGA ONLY)

Some computers and video cards may not allow the auto-sync function to fully work when Cintiq is first connected. If some portion of text appears blurred, open the OSD menu, go to the VGA IMAGE menu, and select AUTO ADJUST. If the image is still blurred, adjust the clock and phase manually by following the procedure below. For optimal display quality, set your video card to the maximum (native) resolution that can be used with Cintiq. See “Product specifications” on page 59 for details.

1. In the Wacom Tablet control panel, select the CALIBRATE tab.
2. If you are working with multiple displays, be sure the option corresponding to Cintiq is selected in the MONITOR menu.
3. Click on the CALIBRATE... button to activate the calibration screen.
4. Using the OSD controls, open the OSD main menu. Select the IMAGE and CLOCK options. Then adjust the clock level so that the pattern of fine vertical stripes displays evenly. (For details on changing the OSD settings, see “On Screen Display (OSD) settings” on page 32.)
5. In the OSD menu select the IMAGE and PHASE options. Adjust the phase level so that the adjustment pattern shows clearly.
6. After completing these adjustments, exit the OSD menu.
7. Click on the CANCEL button or press ESC to exit the calibration screen.



Adjustment pattern for clock and phase. _____

ADJUSTING THE DISPLAY

FACTORY PRESETS, AUTO-SYNC, AND COLOR CALIBRATION

Factory presets: For optimal display quality, set your video card to the maximum (native) resolution that can be used with Cintiq. See the “Product specifications” on page 59 for details.

Auto-sync: Cintiq automatically synchronizes to the incoming signal. The auto-sync function sets the horizontal and vertical screen position, as well as clock and phase. Auto-sync will function between the supported horizontal and vertical frequency ranges. See “Product specifications” on page 59 for details.

If Cintiq does not automatically synchronize with the incoming signal in VGA mode, open the OSD menu, select the VGA IMAGE menu option, and choose AUTO ADJUST to initiate display synchronization. Additional screen display adjustments can be made using the OSD controls.

Color calibration: Changing the color, color temperature, contrast, brightness, or backlight from their default settings will invalidate the ICC color profile that was included on the driver CD.

ON SCREEN DISPLAY (OSD) SETTINGS

The Cintiq OSD function enables you to adjust and optimize a variety of display settings at the touch of a button.

Make adjustments using the OSD controls located on the converter unit.

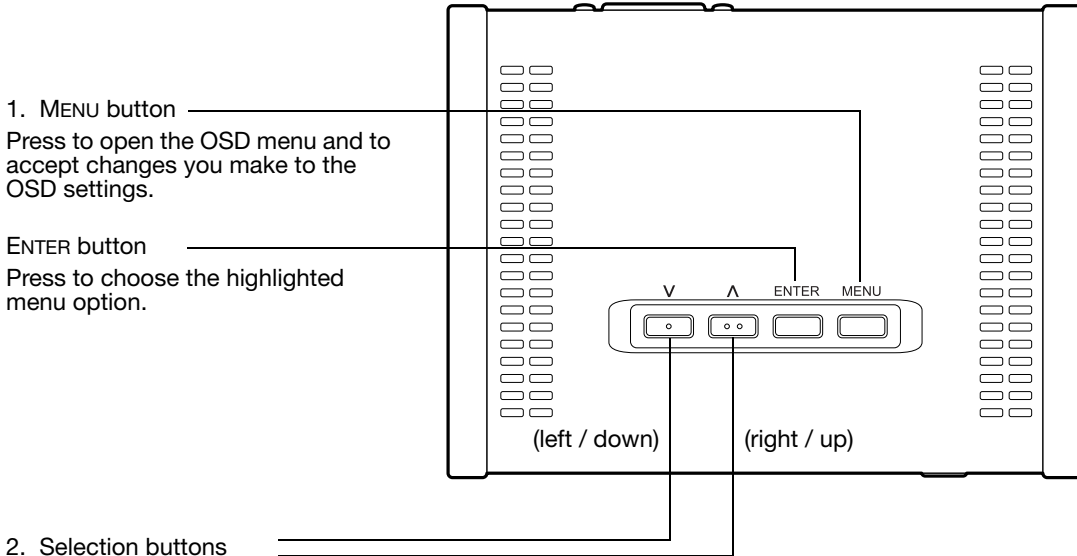

Note: All settings are automatically saved when the OSD menu closes and will be used the next time the unit receives a similar video signal. This is applicable to all display modes. If you make changes to the display appearance and cannot return to the original settings, go to the RESET menu and select the FACTORY RESET option to return Cintiq to its original factory defaults.

The basic process for working with the OSD is as follows:

- Press the MENU button to open the OSD main menu.
- Press the up or down buttons to toggle between the main menu icons. Then press the ENTER button to choose the highlighted icon.



The Main Control icon displays a DVI or VGA identifier, depending on which video interface is currently in use.

- Press the up or down buttons to toggle between menu options. Press the ENTER button to choose the highlighted option. Note that some options, such as POSITION, are not available when in DVI mode.

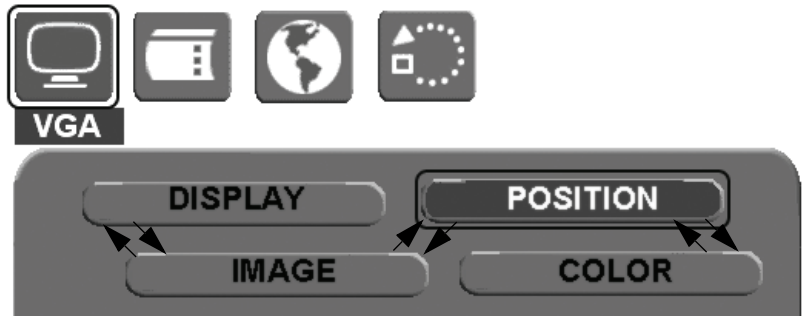

- Press the up or down buttons to select a setting for adjustment. Press the ENTER button to choose the highlighted setting. Note that some settings may not be available when in DVI mode.
- Use the up or down buttons to increase or decrease the setting value.
- Press the MENU button to accept your changes.

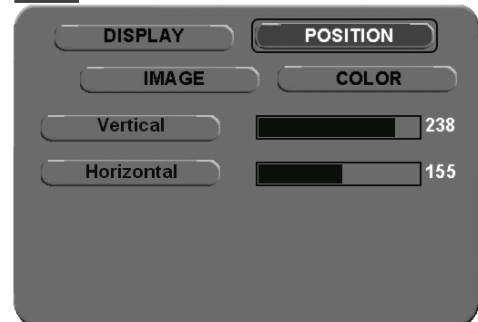

- Note: After changing a setting, the OSD menu will automatically close after a few moments of inactivity. You can also continue to press MENU in order to back out of the OSD menu. All settings are automatically saved when the OSD menu closes. If you make changes to the display appearance and cannot return to the original settings, go to the RESET menu and select the FACTORY RESET option to return Cintiq to its original factory defaults.
- See the following pages for details about the OSD menu options.

When you open the On Screen Display, the main menu icons are displayed.

Main Control.
Provides options (DISPLAY, IMAGE, POSITION, and COLOR) that enable you to fine tune your display settings. See below for details.



Reset.
Returns the display parameters of the current mode to their factory default settings.

OSD Control.
Provides options that enable you to customize the OSD menu. See next page.

Language.
Allows you to choose the language in which the OSD menu will be displayed.



DISPLAY menu options are as follows:

- **BRIGHTNESS.** Increases or decreases the image brightness.
- **CONTRAST.** Increases or decreases image contrast. Note that changes in contrast may affect color accuracy.
- **BACKLIGHT.** Increases or decreases the backlight brightness level.

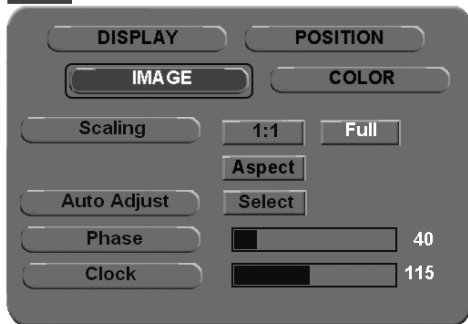
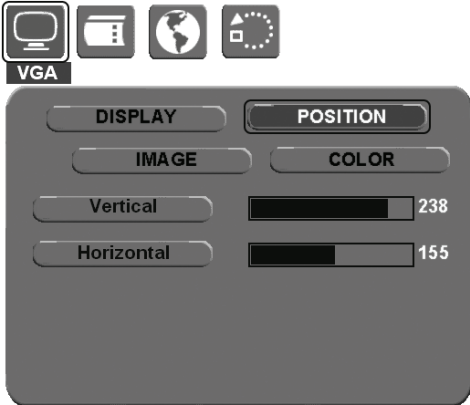

Image menu options are as follows:

- **SCALING.** Enables you to choose how the image is displayed when working at resolutions below 1280 x 800. 1:1 displays the image at the actual resolution. FULL resizes the image to fill the whole screen. ASPECT resizes the image to fill as much of the screen as possible while maintaining the correct aspect ratio.
- **AUTO ADJUST.** (VGA only.) Choose this function to automatically optimize the display screen image.
- **PHASE.** (VGA only.) Synchronizes the signal timing of the pen display to that of your graphics card. Use this adjustment when you experience an unstable or flickering image, or horizontal distortion lines.
- **CLOCK.** (VGA only.) Changes the display data frequency to match that of your graphics card. Use this adjustment when you experience an unstable or flickering image, or vertical distortion lines.



Position menu options (VGA only) are as follows:

- VERTICAL. Changes the vertical position of the image. To automatically adjust, use the AUTO ADJUST option.
- HORIZONTAL. Changes the horizontal position of the image. To automatically adjust, use the AUTO ADJUST option.

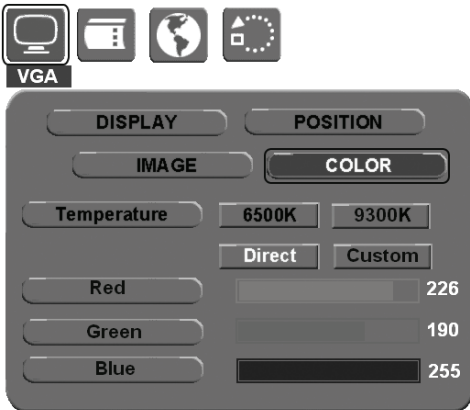

COLOR menu options are as follows:

- TEMPERATURE. Enables you to adjust the pen display color temperature. Provides color temperature settings for 6500° and 9300° Kelvin, as well as DIRECT and CUSTOM options.
- DIRECT displays the colors directly from the video card without any adjustment.
- RED, GREEN, BLUE. After selecting the CUSTOM color option, you can independently adjust the RED, GREEN, and BLUE display colors.

Note: Manual changes made to the color settings will invalidate the Cintiq color profile.

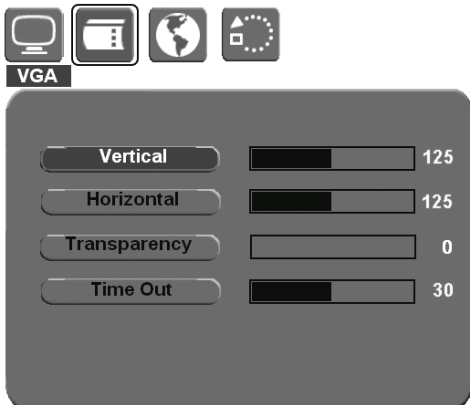

OSD Control menu options are as follows:

- VERTICAL. Adjusts the vertical position of the OSD menu window.
- HORIZONTAL. Adjusts the horizontal position of the OSD menu window.
- TRANSPARENCY. Changes the opaqueness of the OSD menu background.
- TIME OUT. Use this option to set the amount of time the OSD menu will remain displayed with no user input.

POWER SAVING

Cintiq conforms to VESA power saving guidelines.

When using Cintiq with a Display Power Management Signaling (DPMS) compliant computer or video card, the display will automatically comply with the below power saving parameters.

When these power-saving functions are in effect, the screen display is darker than usual.

Computer mode	H-sync	V-sync	Video	Power consumption	Power lamp
Power ON	Yes	Yes	Active	29W	Blue
Standby mode	No	Yes	Blanked	2 W	Orange/blue*
Suspend mode	Yes	No	Blanked	2 W	Orange/blue*
OFF Mode	No	No	Blanked	1 W	Orange

* Depending on the specifications and settings of your computer and video card, the power light may only change to orange when in standby and suspend modes.

TROUBLESHOOTING

Most of the time your interactive pen display will work flawlessly. But if you are having trouble, Wacom recommends you do the following:

1. If the Wacom tablet driver failed to load properly, first perform the recommended action in any error message that may appear on your screen. If that does not solve the problem, continue with the troubleshooting procedures in this chapter.
2. If Cintiq does not function properly, refer to the troubleshooting sections on the following pages. See also “Display troubleshooting” on page 41, or look in the “Pen tablet troubleshooting” on page 44. Your problem may be described there and you can try the solution offered.
3. Open the Wacom pen display Read Me file for any information updates.
4. If you are having a compatibility conflict between Cintiq and a new hardware or software product, see “Obtaining driver downloads” on page 52 for information on downloading an updated software driver. Wacom periodically updates the software driver to maintain compatibility with new products.
5. Check the FAQs (Frequently Asked Questions) on the Wacom web site for your region.
6. If you have tried the suggestions in this manual and still cannot resolve the problem, then contact Wacom for Technical Support. See the Read Me file for information on where to obtain support for your region.

TESTING CINTIQ

1. If the Cintiq power LED does not light, check the following:
 - First verify that the green light on the power adapter is on. If the light is not on, check that the power cable is properly connected to the power adapter and to an active AC outlet.
 - Check that the power adapter cable is securely connected to the Cintiq converter unit.
 - Check also that the Cintiq integrated cable is properly connected to the converter unit and that the Cintiq power switch is turned on. (To unplug the cable, squeeze the connector side clips to release the connector.) The Cintiq power LED will glow orange or blue whenever Cintiq is on.

Important: Use only the AC adapter that came with your pen display. Other adapters may damage your product.

2. If there is no display:
 - Make sure that your computer is turned on. The power LED will light blue when the proper video signal is received, and orange if there is no video signal or if the computer is in a power saving mode.
 - Verify that the Cintiq converter unit is properly connected to an active DVI-I, DVI-D, or VGA connector and that the DVI/VGA switch on the converter unit is set to the correct video setting.
 - Check that your video card has been properly installed and is functional. If you have another display that is compatible with your video card, you can connect that display to the card in order to verify that the video card is operating correctly.
3. Verify that the tablet portion of Cintiq and the Grip Pen are working:
 - Press the pen tip against the display and verify that the status LED lights blue.
 - If the LED does not light, verify that Cintiq's USB cable is properly connected between the converter unit and an active USB port. If the cable is plugged into a USB hub, try plugging it directly into the USB port on your computer.
 - Be sure that the USB port to which you are connecting has not been disabled. It may be necessary to check your system BIOS setting to verify that you have connected Cintiq to an active USB port.
 - The status LED will light blue when Cintiq is registered as a USB device and the pen tip is pressed against the display.
4. Check the pen. If you cannot make a selection on the display screen with the pen:
 - Test the pen by pressing the pen tip or the eraser against the surface of the pen display. The status LED should light blue.
 - Now, without applying pressure to the pen tip but keeping the pen within 5 mm (0.2 inch) of the pen display surface, press the side switch. The status LED should again light blue.
 - If the status LED does not light blue for these tests, be sure you are using the correct pen that came with Cintiq.
 - See "Testing controls and input tools" on page 39 and "Testing a pen" on page 40 for more information.

If you are still having problems, you may have a defective pen or pen display.

After testing, use the Wacom Tablet control panel to reconfigure Cintiq for any custom settings you may originally have been using.

TESTING CONTROLS AND INPUT TOOLS

If the Grip Pen, or the Cintiq ExpressKeys or Touch Strips do not work as you expect, it is a good idea to first check the assigned functions or reset them to their default conditions. A quick way to reset a pen to its default settings is to remove it from the TOOL list by clicking on the list's [-] button. After the pen has been removed, place it back onto the display screen surface and the pen will be re-added to the TOOL list with its default settings.

Open the Wacom Tablet control panel and click on the ABOUT button. In the dialog box that appears, click on the DIAGNOSE... button to open the DIAGNOSTICS dialog box. The DIAGNOSTICS dialog box displays dynamic information about the Cintiq pen display and pen. This information is used when testing Cintiq and your input tool(s).

If more than one Cintiq unit is connected to your system, be sure to select the unit for which you are testing in the TABLET INFO column.

Note: When testing your tool buttons, if a button is set to RADIAL MENU or OPEN/RUN..., that function will occur when the button is pressed. In this case you may want to change the button function before testing.

TESTING THE EXPRESSKEYS

1. With the DIAGNOSTICS dialog box open, observe the TABLET INFO column as you test the ExpressKeys. If you have more than one Cintiq unit connected to your system, be sure to select the unit you are testing from the TABLET INFO column.
2. Test the ExpressKeys by pressing them one at a time. Each time you press a key, its number will be displayed next to either the LEFT KEYS or RIGHT KEYS category, depending on which keys group you are testing.
3. When you are done, click the CLOSE button to exit the dialog box.

Important: Remember that some applications can override and control the ExpressKey functions. Consider closing any open applications except the Wacom Tablet control panel when testing the ExpressKeys.

TESTING THE TOUCH STRIPS

1. With the DIAGNOSTICS dialog box open, observe the TABLET INFO column as you test each Touch Strip. If you have more than one Cintiq unit connected to your system, be sure to select the unit you are testing from the TABLET INFO column.
2. Slide your finger up or down along the entire length of the Touch Strip you want to test. As you touch and move your finger along the Touch Strip, a number will indicate the current finger position for the respective Touch Strip next to LEFT TOUCH STRIP or RIGHT TOUCH STRIP.
3. When you are done, click the CLOSE button to exit the dialog box.

Important: Remember that some applications can override and control the Touch Strip functions. Consider closing any open applications except the Wacom Tablet control panel when testing the Touch Strips.

TESTING A PEN

1. While observing the POINTING DEVICE INFO column, bring your pen within 5 mm (0.2 inch) of the display screen. A value for PROXIMITY, the DEVICE NAME, DEVICE TYPE, and a DEVICE S/N (serial number) should be displayed. If you have more than one Cintiq unit connected to your system, be sure to select the unit for which you are testing a pen in the TABLET INFO column.
2. Move your tool along the tablet surface. The X and Y DATA values should change to reflect the tool position.
3. Test your pen switches. The Cintiq status LED should light blue each time you click with the tool tip, press the side switch, or press the tool's eraser to the display screen.
 - Press on the display screen surface with the tool tip – the SWITCHES state and PRESSURE value should change. (PRESSURE should change from approximately 0% with no pressure applied to approximately 100% when full pressure is applied.)
 - Next, press the side switch without pressing the tip to the tablet – the SWITCHES state should change. (For the Grip Pen, do this for both positions of the DuoSwitch.)

Pen	Tip = 1, DuoSwitch (lower position) = 2, DuoSwitch (upper position) = 3, Eraser = 1
Airbrush	Tip = 1, Side Switch = 2, Eraser = 1
 - Press the tool's eraser to the display screen – the SWITCHES state and PRESSURE value should change. (PRESSURE should change from approximately 0% with no pressure applied to approximately 100% when full pressure is applied.)
 - For the optional Airbrush, move the fingerwheel forward – the WHEEL value should decrease to a value of approximately 0 when the fingerwheel is all the way forward. Move the fingerwheel backward – the WHEEL value should increase to approximately 1000 when the fingerwheel is all the way back.
4. Test tilt for the x-axis by moving the pen from a vertical position toward the right; the X TILT value should change from approximately 0 to +60. Now move the tool to the left of vertical; the X TILT value should change from approximately 0 to -60.
5. Test the tilt for the y-axis by moving the pen from a vertical position toward the bottom of the tablet; the Y TILT value should change from approximately 0 to +60. Now move the tool toward the top of the tablet; the Y TILT value should change from approximately 0 to -60.
6. For the optional 6D Art Pen, test the rotation feature by placing the pen tip on the display screen surface and slowly rotating the pen on its axis. The ROTATION value should change as you rotate the pen.
7. When you are done, click on the CLOSE button to exit the dialog box.

DISPLAY TROUBLESHOOTING

If you encounter problems with the display portion of your Cintiq, see the following tables; your problem may be described here and you can try the solution offered. For more information about color issues, see the documentation that came with your operating system or applications.

GENERAL DISPLAY PROBLEMS

No display. The power LED is off.	Verify that the AC power adapter light is on and the power cable is securely plugged into the Cintiq converter unit's power receptacle. Check that the Cintiq cable is properly connected to the converter unit. (To unplug the Cintiq cable, squeeze the connector side clips to release the connector.) Check also that Cintiq's power switch is turned on.
No display. The power LED is lit blue.	Check the contrast, brightness, and backlight controls. Adjust as necessary, or open the OSD menu, go to the RESET menu and select the FACTORY RESET option.
The power LED is lit orange. No display or a "no sync" message briefly appears on your display screen.	<ul style="list-style-type: none">• Your computer may be in a power management mode. Touch the pen tip to the Cintiq display screen, move the mouse, or depress any key on your keyboard.• Turn off both your computer and the Cintiq pen display, and check the video cable for bent or broken connector pins. Check also the Cintiq integrated cable connector. Then properly reconnect the cables and turn on Cintiq and your computer.• Verify that the DVI/VGA switch is properly set. Restart your computer after changing the position of the switch.• Verify that the video card is properly installed.
No display or a "cable disconnect" message briefly appears on your display screen.	<ul style="list-style-type: none">• Check that your computer is turned on.• Verify that the video cable is properly connected.• Turn off both your computer and the Cintiq pen display, and check the video cable for bent or broken connector pins. Check also the Cintiq integrated cable connector. (To unplug the Cintiq cable, squeeze the connector side clips to release the connector.) Then properly reconnect the cables and turn on Cintiq and your computer.

An “invalid mode” message briefly appears on your display screen.

- The input signal frequency is incorrectly set or not compatible with Cintiq. Set the refresh rate to a vertical frequency that is compatible with Cintiq. If your video card driver supports adjustment of the horizontal frequency, make sure it is set to a compatible value. See “Product specifications” on page 59 for frequency range details. On a single monitor system you will need to connect a different display to change the refresh rate.
- The resolution is set too high (1280 x 800, maximum). See the “Product specifications” on page 59 for details about the maximum (native) resolution, refresh rate, and other resolution sizes that can be used with Cintiq.
- Set the display properties to detect plug and play displays.

The image appears multiple times on the display.

Do not extend the video cable. Do not use an input selector switch box.

When a still image is displayed for a long period of time without refreshing the screen, an after-image remains for a short period of time.

Use a screen saver or other power management feature.

Color quality is inaccurate.

- Open the OSD menu, go to the RESET menu, and select the FACTORY RESET option.
- Be sure the Cintiq color profile has been installed and is selected as the profile for use with your operating system and applications.
- Any changes to the contrast setting should be made in small increments as changes in contrast may affect color accuracy.

The color white does not display as white.

- Be sure the Cintiq color profile has been installed and is selected as the profile for use with your operating system and applications.
- Verify also that the display is operating at the factory default settings. If that is not sufficient, then adjust color as necessary. For details on color management, see your operating system and application documentation.
- Verify that the video cable is fully connected.

VGA PROBLEMS

The display ripples or flickers.

- Open the OSD menu, go to the IMAGE menu, and select the AUTO ADJUST option. If necessary, manually adjust the clock and phase settings.
- Verify that the display adapter or video card matches the specifications for Cintiq.
- Adjust the refresh rate in the Display Properties control panel.

The display is not clear. Text or other portions of the screen appear blurred.

- Set the display resolution of your video card to 1280 x 800. This is the maximum (native) resolution that can be used with Cintiq.
- Turn off the Cintiq, then turn it back on.
- Open the OSD menu, go to the IMAGE menu, and select the AUTO ADJUST option. If necessary, manually adjust the brightness, clock and phase settings.

The display and LCD panel are not lined up. The display size is not correct.

Open the OSD menu, go to the IMAGE menu, and select the AUTO ADJUST option. If necessary, manually adjust clock and phase, and horizontal and vertical position. Note that some video cards may not show the display in proper sizing.

The display ripples or shows a moiré pattern. The display color is not even.

- Open the OSD menu, go to the IMAGE menu, and select the AUTO ADJUST option. If this does not solve the problem, go to the RESET menu and select the FACTORY RESET option to set the display back to the factory default settings.
- Open the OSD menu, and as necessary adjust clock and phase.

PEN TABLET TROUBLESHOOTING

If you encounter problems with the tablet portion of your Cintiq, see the following tables. Your problem may be described here, and you can try the solution offered. Be sure you refer to the Cintiq Read Me file for the latest information.

For additional information, visit Wacom's web site at <http://www.wacom.com/productsupport>

GENERAL PROBLEMS

The computer does not have an available USB port.	Check if there is an available USB port on a USB hub. If not available, you will need to add a USB hub or USB card.
The pen display power LED is off.	Make sure the pen display power switch is turned on. Check that the AC power adapter is plugged into both the pen display converter unit and an active power outlet, and that the green light on the power adapter is on. Check also that the pen display cable is properly connected to the converter unit. (To unplug the Cintiq cable, squeeze the connector side clips to release the connector.) Use only the power adapter that came with the pen display; other adapters may damage your product.
The pen works only in mouse mode, and does not draw with pressure sensitivity.	The tablet driver software was not installed or did not load properly. Make sure the tablet driver software is installed and functioning. Install the pen tablet driver software in accordance with the instructions found in the Installation section of this manual.
The pen does not draw with pressure sensitivity.	Some applications require that you turn on the pressure capabilities within the application or selected tool before the pen will respond as a pressure-sensitive tool.
Clicking is difficult.	Open the Wacom Tablet control panel and go to the PEN tab. Try using a lighter TIP FEEL.
The pen selects everything or will not stop drawing.	Open the Wacom Tablet control panel and go to the PEN tab. Move the TIP FEEL slider toward FIRM, or select the DETAILS... button and increase the CLICK THRESHOLD setting. If this does not help, see "Testing Cintiq" on page 37.

Double-clicking is difficult.	Be sure you are quickly tapping the display screen twice in the same place on the pen display active area. Wacom recommends using the side switch to double-click. Open the Wacom Tablet control panel and go to the PEN tab. Try increasing the TIP DOUBLE CLICK DISTANCE or using a lighter TIP FEEL. <u>Windows:</u> Try setting your system to launch programs with a single click. See “Basic pen operations” on page 19.
The eraser selects everything or will not stop erasing.	Open the Wacom Tablet control panel and go to the ERASER tab. Move the ERASER FEEL slider toward FIRM, or select the DETAILS... button and increase the CLICK THRESHOLD setting. If this does not help, see “Testing Cintiq” on page 37.
You notice a delay at the beginning of pen strokes.	Open the Wacom Tablet control panel and go to the PEN tab. Try decreasing the TIP DOUBLE CLICK DISTANCE. If that does not work, try dragging the TIP DOUBLE CLICK DISTANCE slider to the OFF position in order to turn off double-click assist.
You have to press hard with the pen when clicking or drawing.	Open the Wacom Tablet control panel and go to the PEN tab. Move the TIP FEEL slider toward SOFT, or select the DETAILS... button and decrease the SENSITIVITY and CLICK THRESHOLD settings.
The pen tip does not function.	Be sure you are using the pen that originally came with your pen display, or an Intuos3 pen. Other pens may not function properly on the Cintiq pen display. Make sure the status LED lights blue when the pen tip is pressed. If the LED does not light, verify that the USB cable is plugged into an active USB port on your computer or on a USB hub. If the LED still does not light, you may have defective hardware (see “Troubleshooting” on page 37). Open the Wacom Tablet control panel. Check the control panel’s PEN tab and verify that the tip is assigned to a CLICK function.
Changing the function settings for an input tool has no effect.	Make sure that you change the settings for the tool and application that you are using. See the electronic Software User’s Manual for details on working with multiple tools and with application-specific settings.

The pen side switch does not work.

Be sure you are using the pen that originally came with your pen display, or an Intuos3 pen. Other pens may not function properly.

Be sure you press the side switch when the pen tip is within 5 mm (0.2 inch) of the pen display active area – do this without pressing down on the pen tip.

From the Wacom Tablet control panel, verify that the side switch is set to the proper function you are expecting to occur for the application (and input tool) you are using. Check also which SIDE SWITCH MODE option is selected. (These options are accessed by clicking on the control panel OPTIONS... button.)

Make sure the status LED lights blue when you press the side switch. If the LED does not light, verify that the USB cable is plugged into an active USB port on your computer or on a USB hub.

If the LED still does not light, you may have defective hardware (see “Troubleshooting” on page 37).

The pen tip and screen cursor do not properly line up.

Open the Wacom Tablet control panel and select the CALIBRATE tab. Continue with “Calibrating Cintiq” on page 29.

The screen cursor moves but does not jump to the pen tip location on the display screen, and does not follow the pen tip when the pen is moved across the display.

Make sure the Wacom tablet driver has loaded properly by opening the Wacom Tablet control panel. If the driver did not load you will see an error message. If an error message appears, reboot your computer. If the problem persists, see the Installation instructions and reinstall the Wacom tablet software. (For Macintosh, you must restart your computer after installing the Wacom tablet driver for proper tablet operation.)

If you have customized the side switch on your pen to toggle between PEN mode and MOUSE mode, make sure that your pen display is operating in PEN mode.

When using Cintiq on a multiple display system, you cannot use the pen to control the other display(s).

Make sure that one of the ExpressKeys is set to DISPLAY TOGGLE, and then press that key to cycle between pen control for the Cintiq and your other displays. See the electronic Software User’s Manual for details on working with DISPLAY TOGGLE.

You can also use your pen to control the other displays in MOUSE mode. To use MOUSE mode, first set the pen’s DuoSwitch to MODE TOGGLE.... Then use the switch to toggle between PEN mode and MOUSE mode.

The line you are drawing does not line up with the location of the screen cursor in paint applications.

To function properly, some applications require that the pen is set to PEN mode. Make sure the pen has not been toggled to MOUSE mode.

If the pen is set to PEN mode and the problem still exists, then you may have a corrupted preferences file. Follow the instructions in the Windows or Macintosh troubleshooting sections to create a new preferences file.

The computer does not go to sleep.

When you are not using the pen, remove it from the pen display surface or the Cintiq will continue to send data, keeping the computer awake.

The screen cursor jumps back when using your regular mouse or trackball.

When the pen is not in use, place it in the pen stand, or at some location near the pen display – but not on the display. Leaving your pen on the display may interfere with screen cursor positioning when using other input devices.

The screen cursor moves erratically or jumps around on the display screen when another tablet is connected to your computer.

The tablet portion of Cintiq emits electromagnetic waves at a certain frequency. If another tablet is too closely placed to Cintiq it may interfere with screen cursor positioning. If this occurs, move the tablet further away from Cintiq.

When working in some applications, the ExpressKeys or Touch Strips perform a different function than what is set in the Wacom Tablet control panel.

Some applications can override and control the ExpressKey and Touch Strip functions. See the Software User's Manual for information on using applications integrated for tablet control.

If you use application-specific settings, be sure you have updated the settings for the correct application.

WINDOWS-SPECIFIC PROBLEMS

You suspect the Cintiq preferences may be corrupted, or want to make certain that all settings are at their factory defaults.

Use the Wacom Tablet Preference File Utility to work with your preferences. Close any open applications. Click the START icon and select ALL PROGRAMS. Then select WACOM TABLET and WACOM TABLET PREFERENCE FILE UTILITY.

- It is a good idea to first back up your tablet preferences. In the TABLET PREFERENCE FILE UTILITY dialog box, click BACKUP... and follow the prompts.
- Then, delete the tablet preferences as follows:
 - Single user. In the TABLET PREFERENCE FILE UTILITY dialog box, click the REMOVE button under MY PREFERENCES to delete the preferences for the current user.
 - Multiple users. Click the REMOVE button under ALL USER PREFERENCES to delete preferences for multiple users. Note that administrator rights are required to delete preferences for all users. Relaunch any currently open tablet-aware applications that you may be running.

You can quickly restore tablet preferences that have been backed up by clicking RESTORE... under MY PREFERENCES.

After changing right- and left-handed settings in the computer's mouse control panel, the pen tip no longer functions properly.

Restart Windows for your Wacom tool settings to be correctly recognized.

MACINTOSH-SPECIFIC PROBLEMS

At startup, a dialog box appears telling you that either the driver failed to load or the tablet preferences have not yet been created.

The tablet portion of the pen display was not detected at startup. Make sure the USB interface cable is securely connected to the converter unit and to an active USB port on your computer. Make sure also that Cintiq's power light is on and is glowing blue. If your pen display is plugged into a USB hub, make sure the hub is connected and active. If this does not correct the problem, see "Troubleshooting" on page 37.

From the GO menu, select the UTILITIES folder and launch the SYSTEM PROFILER. Select USB from the HARDWARE section of the CONTENTS list. A Wacom USB pen display model should be listed. If a pen display model is not listed, check the pen display's USB cable connection or try plugging the pen display into a different USB port.

If this does not help, contact Wacom for Technical Support. See "Technical support options" on page 51.

You suspect the pen display preferences may be corrupted, or want to make certain that all settings are at their factory defaults.

Use the Wacom Tablet Utility to work with your preferences. Close any open applications. Open the main APPLICATIONS folder. Then open the WACOM TABLET folder and run the WACOM TABLET UTILITY.

- It is a good idea to first back up your tablet preferences. In the WACOM TABLET UTILITY dialog box, select CURRENT USER or ALL USERS. Then click BACKUP... and follow the prompts.
- Then, delete the tablet preferences as follows:
 - Single user. When the utility starts, select CURRENT USER and click on the REMOVE button. Log out, then log back in. When the pen display driver loads it will create a new preferences file with the factory defaults.
 - Multiple users. When the utility starts, select ALL USERS and click on the REMOVE button. Log out, then log back in. When the pen display driver loads it will create new preferences files with the factory defaults.

You can quickly restore tablet preferences that have been backed up for the CURRENT USER or ALL USERS by clicking on the RESTORE... button within the utility.

Note: Do not manually remove the WACOM TABLET.PREFFPANE file from the main LIBRARY PREFERENCEPANES folder. This file is only to be removed when uninstalling the Wacom software driver, and then only when using the WACOM TABLET UTILITY.

Recalibrate the pen display.

Ink does not work correctly with Cintiq.

There may be a problem with the Ink preferences. Remove the damaged preference files as follows. They will be recreated when you enable handwriting recognition.

1. Open the SYSTEM PREFERENCES pane, choose SHOW ALL and select INK. Then turn off handwriting recognition.
2. From the GO menu, choose your HOME. Open the LIBRARY and PREFERENCES folders. Then remove the following preferences:
 - COM.APPLE.INK.FRAMEWORK.PLIST
 - COM.APPLE.INK.INKPAD.PLIST
 - COM.APPLE.INK.INKPAD.SKETCH
3. Go back to SYSTEM PREFERENCES and INK, and then enable handwriting recognition.
4. Test the Ink function using your Wacom pen display and pen.

If this procedure does not resolve your problem with Ink, contact Apple Support for further assistance. Wacom is not the software manufacturer for Ink and we are limited in our abilities to support a third-party software application.

TECHNICAL SUPPORT OPTIONS

If you have a problem with your Cintiq pen display, first check the Installation section in this guide to make sure the unit is installed correctly. Then review the Troubleshooting procedures.

If you cannot find the answer in this guide, you may find updated information about your problem in the appropriate Read Me file for your platform (located on the Wacom Pen Tablet Driver CD). You can also check the product FAQs (Frequently Asked Questions) on the Wacom web site for your region.

If you have an Internet connection you can download the latest software drivers from the Wacom web site for your region. See “Obtaining driver downloads” on page 52.

If you cannot solve the problem and you think your Wacom product is not working properly, contact the Wacom support staff for the area where your product was purchased. See the Wacom tablet Read Me file, located on the Wacom Pen Tablet Driver CD, for contact information.

When you call, you should be at your computer with the following information available:

- This manual.
- Pen display serial number. (See the label on the back of the unit.)
- Driver version number. (See the Wacom Pen Tablet Driver CD or click on the Wacom Tablet control panel About button.)
- The make and model of your computer, and operating system version number.
- The make, model, and connection type of your video card.
- A list of peripheral devices attached to your computer.
- The software application and version you were using when the problem occurred.
- The exact wording of any error message that appeared on your screen.
- What happened and what you were doing when the problem occurred.
- How you tried to solve the problem.

OBTAINING DRIVER DOWNLOADS

Wacom periodically updates the pen tablet software driver to maintain compatibility with new products. If you are having a compatibility problem between your Cintiq pen display and a new hardware or software product, it may be helpful to download a new Wacom tablet software driver (when available) from the Internet.

USA, Canada, Central and South America

Worldwide Web: <http://www.wacom.com/productsupport> Software updates.

Europe, Middle East and Africa

Worldwide Web: <http://www.wacom.eu/downloads> Software updates.

Japan

Worldwide Web: <http://tablet.wacom.co.jp/download> Software updates. (Japanese)

Asia Pacific (English)

Worldwide Web: <http://www.wacom-asia.com> Software updates. (English)

China

Worldwide Web: <http://www.wacom.com.cn> Software updates.
(Simplified Chinese)

Korea

Worldwide Web: <http://www.wacomkorea.com> Software updates. (Korean)

Taiwan

Worldwide Web: <http://www.wacom.com.tw> Software updates.
(Traditional Chinese)

APPENDIX

CARING FOR CINTIQ

Keep the Grip Pen and your Cintiq LCD screen surface clean. Dust and dirt particles can stick to the pen and cause excessive wear to the display screen surface. Regular cleaning will help to prolong the life of your LCD screen surface and pen.

Keep Cintiq, the converter unit, and the Grip Pen in a clean, dry place and avoid extremes in temperature. Room temperature is best. Cintiq, the converter unit, and the Grip Pen are not made to come apart. Taking apart the product will void your warranty.

Important: Take care to never spill liquids onto the pen display, converter unit, or pen. Be especially careful of getting the display, tablet ExpressKeys, Touch Strips, converter unit, or pen buttons, tip, and eraser wet – they contain sensitive electronic parts that will fail if liquids enter them.

CLEANING

To clean the Cintiq or converter unit casing or the Grip Pen, use a soft, damp cloth; you can also dampen the cloth using a very mild soap diluted with water. Do not use paint thinner, benzine, alcohol, or other solvents to clean the unit casing or pen.

To clean the display screen, use an anti-static cloth or a slightly damp cloth. When cleaning, apply only a light amount of pressure to the display screen and do not make the surface wet. Do not use detergent to clean the display screen; this may damage the coating on the screen. Please note that damage of this kind is not covered by the manufacturer's warranty.

REPLACING THE PEN TIP

The pen tip (nib) will wear with normal use. Excessive pressure will cause the nib to wear sooner. When the nib gets too short or develops a sharp edge, replace it with one of the extra nibs that came with the pen.

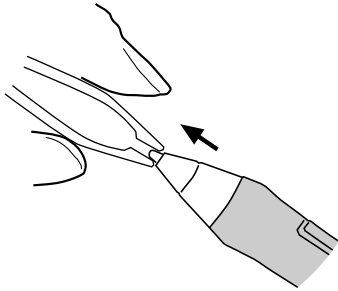

To remove the old nib:

Clasp it with a Wacom nib extractor, pair of tweezers, needle-nosed plier, or similar instrument and pull the old nib straight out of the pen.

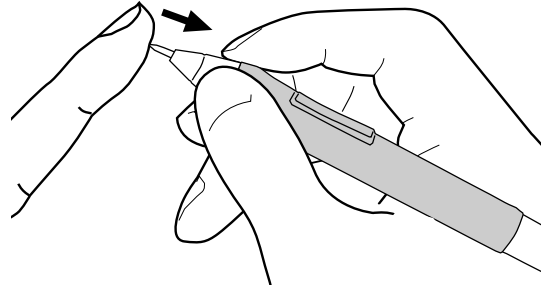

To insert a new nib:

Slide it straight into the barrel of the pen. Firmly push the nib until it stops. The new nib will slide into the correct position.

Warning Choking hazard. Prevent children from swallowing the pen tip or side switch. The pen tip (nib) or side switch may accidentally be pulled out if children are biting on them.

If the pen nib wears and becomes angular, it may damage the coating on the Cintiq display screen. To avoid this, periodic nib replacement is recommended.

Important: When the pen is not in use, place it in the pen stand or lay it flat on your desk. To maintain the sensitivity of your pen, do not store the tool in a container where it will rest on its tip or eraser.

USING A MOUNTING FIXTURE

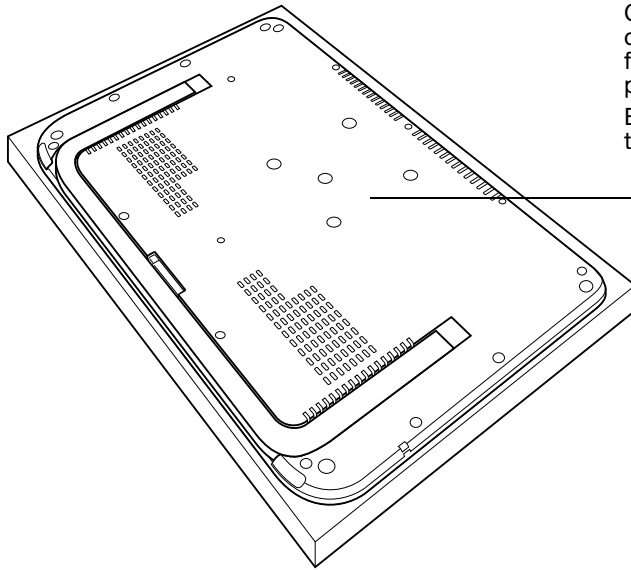

Cintiq can be attached to any mounting fixture conforming to the VESA 75 standard. This requires four M4 Regular screws (4 mm diameter with 0.7 mm pitch) with a clearance depth of no more than 6 mm. Exceeding the screw length may result in damage to the display.

Attaching to a fixture:

1. Turn off your computer and power off Cintiq. Disconnect the power cable from the converter unit, and then the Cintiq cable from the converter unit.
2. Close the Cintiq stand and place the unit face down on a flat, soft surface (such as a cloth spread across a desktop).
3. Firmly attach Cintiq to the fixture using four M4 Regular screws (4 mm diameter with 0.7 mm pitch).

Important: Make sure the screw clearance depth does not exceed 6 mm, or the screws will damage the Cintiq.

Caution  When attaching Cintiq onto a VESA standard fixture, be sure to follow all instructions in the documentation supplied by the fixture manufacturer. If improperly secured, the unit could fall, resulting in damage to the unit or physical injury.

4. Reattach the Cintiq cable to the converter unit.

Removal from the fixture:

To remove the fixture at a later time, reverse the above steps.

PEN AND DIGITAL INK CAPABILITIES IN WINDOWS

Microsoft Windows 7 and Vista provide extensive support for pen* input. When using Cintiq with a computer running Windows 7 or Vista, your experience is enhanced by powerful note taking, handwriting recognition, fast navigation, and other digital inking options designed to give you quick, intuitive results with the Wacom pen.

- **Note taking.** Use your Wacom pen to jot notes and capture quick sketches in Windows Journal. Journal simulates a physical notebook, but with the advantages of digital note taking. You can choose from a variety of pen, marker, and highlighter tools, plus an eraser that is easily activated by the eraser end of your Wacom pen. Journal also includes a powerful search engine that can even locate your handwritten content.
- **Handwriting recognition.** Because Windows 7 and Vista include powerful handwriting recognition capabilities, you can use your Wacom pen to quickly enter handwritten information anywhere the computer accepts typed input. You can convert your handwritten content to typed text at any time.
- **Gestures.** Use your Wacom pen to make simple gestural movements on the tablet to trigger customizable actions for navigation, editing, and other functions. To customize your gestures, select the FLICKS tab in the PEN AND INPUT DEVICES control panel.
- **Digital Ink in Microsoft Office 2007.** Use your Wacom pen to full advantage with the enhanced digital mark-up and inking tools available in Microsoft Office 2007 or later applications running on Windows 7 or Vista. Found on the REVIEW tab within applicable applications, these tools provide a consistent set of inking options. For quick access, you can add specific inking tools to the Quick Access Toolbar located at the top of each application.

To make the most of the pen in Microsoft Windows, be sure to study the documentation that came with your system, including the Windows training tools and Tablet PC tutorial. You can access the Tablet PC Pen Training from the START menu by choosing ALL PROGRAMS, TABLET PC, and TABLET PC PEN TRAINING.

Note: The following workarounds in the software driver for the tablet portion of the pen display improve performance in Windows 7 and Vista:

- The Pen Flicks and 'press-and-hold-to-right-click' features are disabled in graphics applications using the Wintab API.
- There is no pressure sensitivity in Journal and other Ink features when both the Flicks and 'press-and-hold-to-right-click' features are disabled in the PEN AND INPUT DEVICES control panel.

* Pen features supported in all versions of Windows 7 and Vista except Windows 7 Starter and Home Basic, and Windows Vista Home Basic.

ABOUT THE WINDOWS TABLET PC INPUT PANEL

The Windows 7 or Vista Tablet PC Input Panel enables you to use handwriting or an on-screen keyboard to directly enter text with your Wacom pen. There are a number of ways to launch the Input Panel:

- Click on the Input Panel icon which appears when you move the screen cursor into a text entry area.
- Click on the Input Panel tab, located by default on the left edge of the display screen.
- Click on the Tablet PC Input Panel icon located on the Windows taskbar. If the icon is not visible, right-click on the taskbar, select TOOLBARS, and TABLET PC INPUT PANEL.

To customize the Input Panel:

1. First open the Input Panel and then click on TOOLS in the menu bar.
2. Select OPTIONS to open the Input Panel Options dialog box.
3. Customize the Input Panel settings for the way you like to work.

To learn more about using your Wacom pen in Microsoft Windows and Office 2007 or later, study the documentation that came with your system and Microsoft Office applications. Be sure to take advantage of the Windows training tools, including the Tablet PC tutorial, available from Microsoft.

You can visit also the Wacom web site at www.wacom.com/vista for additional information on working with your Wacom pen in Windows.

UNINSTALLING CINTIQ

Follow the appropriate procedure below to remove the Wacom tablet software and Cintiq pen display from your system.

Important: When you remove the Wacom tablet software from your system, your Wacom tablet will no longer operate with full tablet functionality but will continue to function as a mouse device.

Windows:

1. Click on the Windows START button and open the CONTROL PANEL.
2. In the CONTROL PANEL window for
 - Windows 7 and Vista: click on UNINSTALL A PROGRAM. In the dialog box that appears, choose the WACOM TABLET option and click on the UNINSTALL button.
 - Windows XP or XP x64: select ADD OR REMOVE PROGRAMS. In the ADD OR REMOVE PROGRAMS window, choose WACOM TABLET and click on the REMOVE button.
3. Follow the prompts to remove the tablet driver. (If prompted, enter your administrator login name and password.)
4. When the driver has been removed, shut down your system, power off your computer, and turn off Cintiq. When your computer and Cintiq are off, disconnect Cintiq from your computer.

Macintosh:

1. From the GO menu, choose APPLICATIONS and open the WACOM TABLET folder.
2. Double-click on the REMOVE WACOM TABLET icon and select the REMOVE TABLET SOFTWARE button. Enter your administrator login name and password.
3. After the removal is completed, click OK.
4. Shut down your computer and turn off Cintiq. When your computer and Cintiq are off, disconnect Cintiq from your computer.

PRODUCT SPECIFICATIONS

CINTIQ 12WX (MODEL DTZ-1200W) GENERAL SPECIFICATIONS

Dimensions (W x D x H)	405.2 x 269.7 x 17 mm (15.96 x 10.63 x 0.67 in), excluding rotation pivot
Weight	1.8 kg (3.96 lb)
Input voltage	12 VDC
Power management	VESA DPMS
Power consumption (with AC adapter)	29W maximum 2 W or less in sleep mode (USB non-connected) 1 W or less in off mode
Compatibility	Windows: 7, Vista, XP (32 and 64 bit) Macintosh: OS X, v10.4 or later
Stand	Flat on desktop, incline 30 to 65 degrees from vertical
Interface cables	DVI-I to VGA, DVI-I to DVI-D, USB
Cover plate	Tempered AG etching glass with AR film (back side)
Operating temperature and humidity	5° to 35° C, 20 to 80% RH (non-condensing)
Storage temperature and humidity	-10° to 60° C, 20 to 90% RH (non-condensing) (maximum storage humidity is 38% at a temperature of 60° C, and maximum storage temperature is 42° C at a humidity of 90%)
Certification and compliance	FCC Part 15 Subpart B (Class B) and C, CE, VCCI Class B, C-tick, BSMI, KCC, CB, CCC, GOST-R, The European Union RoHS Directive 2002/95/EC, Chinese RoHS, Korean RoHS

DISPLAY

Display	a-Si active matrix TFT LCD (IPS type)
Screen size	12.1 inch (261.1 x 163.2 mm (10.3 x 6.4 in))
Aspect ratio	16 : 10
Input video connector	DVI-I (29 pin)
Input video signal	Digital: DVI 1.0 compliance / analog RGB
Output video connector	No video output
Output video signal	No video output
Supported resolutions	1280 x 800 pixels, 1024 x 768, 800 x 600, 640 x 480 pixels
White luminance uniformity	70%, typical
Pixel pitch	0.204 (H) x 0.204 (V) mm (0.01 x 0.01 in)
Viewing angles @ CR10:1 (horizontal/vertical)	170(85/85) / 170(85/85), typical
Display colors	16.7 million colors
Pixels	1280 x 800
Response time (Tr + Tf)	25 ms (typ.)
Luminance	180 cd/m2 (typ.)
Contrast ratio	600:1 (typ.)
OSD manual control	Brightness, Contrast, Clock, Phase, Vertical position, Horizontal position, Transparency, Time Out, Auto-Adjust, Language, Backlight, Menu Position, Scaling, Color temperature (9300K/6500K/CUSTOM/DIRECT), Reset
Plug and Play	DDC 2B, DDC/CI
LCD quality	Each LCD panel is produced under very stringent quality standards. Production techniques cannot guarantee an absolutely perfect TFT display. Wacom does not allow any pixel to be always white or always black. A small number of pixels are allowed to show a wrong color for some parts of the color spectrum. This does not mean the display is defective.

PEN TABLET

Reading technology	Electromagnetic resonance technology
Active area	261.1 x 163.2 mm (10.3 x 6.4 in)
Resolution	0.005 mm/point (5080 lpi)
Accuracy	±0.5 mm (±0.02 in), center Edge area 1 (20 mm wide from edge of display area) to be ±2.0 mm (±0.08 in) Edge area 2 (3 mm wide from edge of display area) to be ±4.0 mm (±0.16 in)
Pen tilt range	40 degrees from vertical (except for corners)
Pen tilt levels	±60 levels
Reading height	5 mm (0.2 in) or more, center
Report rate	136 points/sec.
Pressure levels	1024 levels
Communication interface	USB

CONVERTER UNIT

Dimensions (W x D x H)	148.0 x 112.0 x 27.6 mm (5.83 x 4.41 x 1.09 in), excluding foot pads
Weight	0.3 kg (0.66 lb)
Video input	DVI or VGA (DVI incl. DDC/CI, DDC 2B)
Tablet interface	USB
Output	Proprietary video and USB interface
Input voltage	12VDC

POWER ADAPTER

Input voltage	100 to 240 VAC, 50/60 Hz
Output voltage	12 VDC, 3.33 A (max.)

GRIP PEN (MODEL ZP-501E)

Pen tip travel	0.2 mm (0.008 in) or less
Pressure levels	1024 levels
Eraser tip travel	1.5 mm (0.06 in), approximately
Dimensions (L x D)	174.8 x 14.8 mm (6.89 x 0.58 in)
Weight	17 g (0.60 oz), approximately
Tip types	Standard nib, Polyacetal (POM), black (3) – for general, multi-purpose use. Stroke nib, spring loaded, gray (1) – for a brush-like feeling. Felt nib, black (1) – provides a higher friction than the other nibs.

ACCESSORIES

Airbrush. A true digital airbrush incorporating a pressure-sensitive tip and eraser, tilt sensitivity, and a fingerwheel that provides an additional degree of control over the application of digital paint. This tool also includes a programmable side switch.



ZP-400E

6D Art Pen. This pen provides rotation sensing technology with a unique chisel-shaped nib that emulates brushes, markers, and calligraphic pens. Simply by rotating the pen, a drawn line becomes narrow or broad. When the 6D Art Pen is combined with a software application supporting its feature set, the pen can produce almost any type of brush effect or marker stroke.

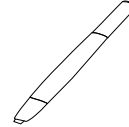

ZP-600

Classic Pen. This pressure-sensitive pen has the same feature set as the Cintiq Grip Pen, but with a slimmer profile that does not include a rubberized grip.



ZP-300E

Replacement nibs

Standard nibs, polyacetal, (white) for Grip Pen (model ZP-501E), Airbrush (model ZP-400E), or Classic Pen (model ZP-300E)

PSI-A007, qty 5

Stroke nib (gray) for Grip Pen, Airbrush, or Classic Pen. Stroke nibs are spring-loaded, providing additional tactile feedback when you are working with the Grip Pen or Airbrush. They are installed in the same manner as a standard pen nib.

PSI-A042, qty 5

Felt nib, for Grip Pen (model ZP-501E), Airbrush (model ZP-400E), or Classic Pen (model ZP-300E)

PSI-A043, qty 5

Standard nib, for Art Pen (model ZP-600)

PSI-A052, qty 5

Felt nibs, for Art Pen (model ZP-600)

PSI-A051, qty 5

Pen stand, for Grip Pen and Art Pen

PST-A034

Pen tether

FUZ-A108

PRODUCT INFORMATION

To learn more about your interactive pen display and how to take full advantage of the many pen and digital inking features in Microsoft Windows 7 and Vista, visit the Wacom web site for your region:

USA, Canada, Central and South America	http://www.wacom.com/productinfo
Europe, Middle East and Africa	http://www.wacom.eu
Japan	http://tablet.wacom.co.jp
Asia Pacific (English)	http://www.wacom-asia.com
China (Simplified Chinese)	http://www.wacom.com.cn
Korea	http://www.wacomkorea.com
Taiwan	http://www.wacom.com.tw
Thailand	http://www.wacom-thai.com

ORDERING PARTS AND ACCESSORIES

To purchase parts and accessories, refer to the Cintiq Read Me file and see who to call for your region.

You can also do the following:

- To purchase parts and accessories in the USA or Canada, call 1.888.884.1870 (toll-free) or visit Wacom's web site at <http://www.WacomDirect.com> (USA only).
- To purchase parts and accessories in Europe, call +49 (0)180.500.03.75 or send an email to spareparts@wacom.eu. Or, visit <http://shop.wacom.eu>. You can also contact your local dealer, distributor, or technical support using the appropriate number for your region.
- To purchase parts and accessories in Australia, Singapore, Taiwan and Korea, please visit: www.BuyWacom.com.au, www.BuyWacom.com.sg, www.BuyWacom.com.tw and www.BuyWacom.co.kr, respectively.
- To purchase parts and accessories in other countries, please contact your local dealer or distributor.

Please note that not all parts and accessories may be available in all regions.

RADIO AND TELEVISION INTERFERENCE

The equipment described in this manual generates, uses, and can radiate radio-frequency energy. If it is not installed and used properly – that is, in strict accordance with Wacom instructions – it may cause interference with radio and television reception.

FEDERAL COMMUNICATIONS COMMISSION (FCC) NOTICE

This device complies with Part 15 of the FCC Rules. Operation is subject to the following two conditions: (1) this device may not cause harmful interference, and (2) this device must accept any interference received, including interference that may cause undesired operation.

This equipment has been tested and found to comply with the limits for a Class B digital device, pursuant to Part 15 of FCC Rules. These limits are designed to provide reasonable protection against harmful interference in a residential installation.

This equipment generates, uses and can radiate radio frequency energy and, if not installed and used in accordance with the instructions, may cause harmful interference to radio communications. However, there is no guarantee that interference will not occur in a particular installation.

You can determine whether the equipment is causing interference by powering it off. If the interference stops, it was probably caused by the equipment.

If the equipment does cause interference to radio or television reception, you may be able to correct the interference by using one or more of the following measures:

- Rotate the television or radio antenna until the interference stops.
- Move the equipment farther away from the television or radio.
- Plug the equipment and computer into an outlet that is on a different circuit from the television or radio.

If necessary, consult your Wacom dealer or an experienced radio/television technician for help.

Changes or modifications to this product not authorized by Wacom could void the FCC Certification and negate your authority to operate the product.

INDUSTRY CANADA (CANADA ONLY)

Industry Canada, Class B

“This Class (B) digital apparatus complies with Canadian ICES-003”

“Cet appareil numérique de la classe (B) est conforme à la norme NMB-003 du Canada.”

CE DECLARATION

The Cintiq 12WX pen display has been tested and found to comply with the following harmonized European Norms:

- EN 55022: 2006, Class B
- EN 61000-3-2: 2000+A2:2005, Class D
- EN 61000-3-3: 1995+A1:2001+A2:2005
- EN 55024: 1998+A1:2001+A2:2003
 - IEC61000-4-2: 2001 ED.1.2
 - IEC61000-4-3: 2006 ED.3.0
 - IEC61000-4-4:2004 ED.2.0
 - IEC61000-4-5: 2005 ED.2.0
 - IEC61000-4-6: 2006 ED.2.2
 - IEC61000-4-8: 2001 ED.1.1
 - IEC61000-4-11: 2004 ED.2.0
- IEC 62301:2005 1Ed.

Based on the results of these tests, Wacom declares that the above mentioned device conforms to the EMC Directive 2004/108/EC.

The device must be installed and operated always in strict accordance to the instructions given in this manual. Any changes or modifications to this product that were not specifically authorized by Wacom will invalidate this declaration.

COMMISSION REGULATION (EC) No 1275/2008 of 17 December 2008 implementing Directive 2005/32/EC of the European Parliament and of the Council with regard to ecodesign requirements for standby and off mode electric power consumption of electrical and electronic household and office equipment.

WARRANTY

(WORLDWIDE, EXCEPT FOR EUROPE, AFRICA AND MIDDLE EAST)

LIMITED WARRANTY

Wacom warrants the product, to the original consumer purchaser, except for the Software and consumable items such as the pen nibs, to be free from defects in materials and workmanship under normal use and service for a period of two (2) years, from the date of original retail purchase, as evidenced by a copy of the receipt and registration with Wacom within 30 days of purchase.

The Software is licensed “as is.” Wacom makes no warranty with respect to its quality or performance. Wacom cannot guarantee you uninterrupted service or the correction of any errors.

Upon discovery of a defect in the product, except in the Software, within the Warranty Period, you should contact Wacom Technical Support via telephone, email, or fax to obtain an RMA (Return Merchandise Authorization) number and instructions for shipping the product to a service location designated by Wacom. You should send the product, shipping charges prepaid, to the designated service location, accompanied by the return authorization number, your name, address and telephone number, proof of purchase date, and a description of the defect. Wacom will pay for return shipping by United Parcel Service or by an equivalent service as chosen by Wacom.

Wacom’s sole obligation and entire liability under this warranty shall be, at Wacom’s option, either the repair or replacement of the defective product or parts thereof of which Wacom is notified during the Warranty Period; provided, however, that you are responsible for (i) the cost of transportation of the product to the designated service location and (ii) any loss or damage to the product resulting from such transportation.

Wacom shall have no responsibility to repair or replace the product if the failure of the product has resulted from accident, abuse, misuse, negligence, or unauthorized modification or repair, or if it has been handled or stored other than in accordance with Wacom’s storage instructions.

Any descriptions, drawings, specifications, samples, models, bulletins, or similar material, used in connection with the sale of the product, shall not be construed as an express warranty that the product will conform or comply with your requirements.

EXCEPT FOR THE LIMITED WARRANTY DESCRIBED ABOVE, THERE ARE NO OTHER WARRANTIES MADE BY WACOM ON THIS PRODUCT. NO ORAL OR WRITTEN INFORMATION OR ADVICE GIVEN BY WACOM, ITS DEALERS, DISTRIBUTORS, AGENTS, OR EMPLOYEES SHALL CREATE A WARRANTY OR IN ANY WAY INCREASE THE SCOPE OF THIS WARRANTY, AND YOU MAY NOT RELY ON ANY SUCH INFORMATION OR ADVICE. THIS WARRANTY GIVES YOU SPECIFIC LEGAL RIGHTS, AND YOU MAY ALSO HAVE OTHER RIGHTS WHICH VARY FROM STATE TO STATE.

WACOM LIMITS THE DURATION OF ANY LEGALLY IMPLIED WARRANTIES INCLUDING IMPLIED WARRANTIES OF MERCHANTABILITY OR FITNESS FOR A PARTICULAR PURPOSE, TO THE DURATION OF WACOM’S EXPRESS WARRANTY. SOME STATES DO NOT ALLOW LIMITATIONS ON HOW LONG AN IMPLIED WARRANTY LASTS, SO THE ABOVE LIMITATION MAY NOT APPLY TO YOU.

NEITHER WACOM NOR ANYONE ELSE WHO HAS BEEN INVOLVED IN THE CREATION, PRODUCTION, OR DELIVERY OF THIS PRODUCT SHALL BE LIABLE FOR ANY DIRECT, CONSEQUENTIAL, OR INCIDENTAL DAMAGES (INCLUDING DAMAGES FOR LOSS OF BUSINESS PROFITS, BUSINESS INTERRUPTION, LOSS OF BUSINESS INFORMATION AND THE LIKE) ARISING OUT OF THE USE OF OR INABILITY TO USE SUCH PRODUCT, EVEN IF WACOM HAS BEEN ADVISED OF THE POSSIBILITY OF SUCH DAMAGES. SOME STATES DO NOT ALLOW THE EXCLUSION OR LIMITATION OF INCIDENTAL OR CONSEQUENTIAL DAMAGES, SO THE ABOVE LIMITATION OR EXCLUSION MAY NOT APPLY TO YOU.

In the event that any of the above limitations are held unenforceable, Wacom’s liability for any damages to you or any party shall not exceed the purchase price you paid, regardless of the form of any claim.

This Limited Warranty is governed by the laws of the United States of America and the state of Washington.

This Limited Warranty is valid for and only applies to products purchased and used inside the United States (and its territories or possessions) and Canada.

WARRANTY SERVICE IN THE U.S.A. AND CANADA

To obtain Warranty service within the U.S. or Canada contact:

Wacom Customer Care Center

Phone: 1.360.896.9833

Email Inquiry form: <http://www.wacom.com/productsupport/email.cfm>

WARRANTY SERVICE OUTSIDE OF THE U.S.A. AND CANADA

For products purchased or used outside of the United States and Canada, the warranty period is one (1) year from the date of original retail purchase. Upon discovery of a defect in the product, except in the Software, within the Warranty Period you should contact your local dealer or distributor. If an authorized Wacom repair center is not available in your local country you will be responsible for all transportation costs including duties and taxes to and from the Wacom repair center. In all other respects the terms of the warranty as set forth above apply to such sales.

Wacom Technical Support in Asia Pacific (except Japan and China)

Detailed Asia Pacific Limited Warranty policy and product registration may be found online at <http://www.wacom-asia.com>

To obtain technical support or Warranty service within Southeast Asia, Oceania and Taiwan, please contact the Wacom Customer Support Service.

Phone numbers can be found here: <http://www.wacom-asia.com/support/contact>

Should you have any questions about this Agreement, or if you desire to contact Wacom for any reason, please contact in writing:

IN NORTH AND SOUTH AMERICA CONTACT:

Wacom Technology Corporation

1311 SE Cardinal Court

Vancouver, Washington 98683

U.S.A.

IN JAPAN CONTACT:

Wacom Co., Ltd.

Harmony Tower 21F, 1-32-2 Hon-Cho

Nakano-Ku, Tokyo 164-0012

Japan

Internet: <http://tablet.wacom.co.jp>

IN ASIA PACIFIC CONTACT:

Wacom Co., Ltd.

Asia Pacific Office

Harmony Tower 18F, 1-32-2 Hon-Cho,

Nakano-Ku, Tokyo 164-0012

Japan

IN MAINLAND CHINA (EXCEPT HONG KONG) CONTACT:

Wacom China Corporation

Unit 2807, 28th Floor, SK Tower

No 6 Jia, Jianguomenwai Avenue,

Beijing, 100022, China

E-mail: support@wacom.com.cn

LICENCE WARRANTY CONDITIONS (EUROPE, AFRICA AND MIDDLE EAST)

SOFTWARE LICENCE AGREEMENT

Important customer information

The scope of delivery of this product covers copyright-protected computer programs ("software"), which are the inalienable intellectual property of WACOM Europe GmbH ("WACOM"). This software is an integral component of the product and is also held on the associated data carrier. The software of WACOM and the associated rights of use are not included with the purchase of this product from your retailer. WACOM grants you-the user-the right to use the software exclusively in accordance with the conditions stipulated in this licence agreement. By purchasing this product, you agree to the following licence conditions.

Conditions for using the software

WACOM issues the user with a personal, non-exclusive licence to use the software solely in connection with this product and for the correct operation of the product. This licence may only be assigned to a third party in connection with this product.

Use of this software includes the creation of permanent or temporary copies of the software by means of loading, displaying, exporting, transferring or saving, for the purposes of exporting the commands and the data they contain or for observing, researching or testing the software functions.

The customer may not license the software to a third party, lease, lend or in any other way provide access to the software. The customer may not copy, change, transfer or edit the software without prior written agreement from WACOM. The only exceptions to this are necessary procedures for creating a back-up copy and the scenarios outlined in section 2.

The customer may not carry out any "reverse engineering", decompile or depacketise the software, or try by any other means to discover the source code of the software. This restriction shall continue to apply after the termination of this agreement. If the software contains interfaces to other programs that are not supported by WACOM, WACOM shall provide the customer with the necessary information on request, as long as the customer can prove his right to use the software and agrees to bear the copying and postage costs.

WACOM AND ITS SUPPLIERS CANNOT OFFER ANY GUARANTEE FOR THE PERFORMANCE OF THE SOFTWARE OR FOR THE RESULTS PRODUCED THERE FROM. WACOM AND ITS SUPPLIERS OFFER NO GUARANTEES OR ASSURANCES (EITHER EXPRESSLY OR IMPLICITLY, INCLUDING THOSE THAT MAY BE DERIVED FROM A BUSINESS RELATIONSHIP OR FROM TRADE PRACTICE, OR FROM LEGAL PROVISIONS OR CUSTOMARY LAW) WITH REGARD TO THE MARKETABILITY, FREEDOM FROM DEFECTS OF TITLE OR USEFULNESS OF THE SOFTWARE.

WACOM AND ITS SUPPLIERS ACCEPT NO LIABILITY FOR DAMAGES, CLAIMS OR COSTS OF ANY KIND, NOR FOR CONSEQUENTIAL DAMAGES, SECONDARY, ACCIDENTAL, INDIRECT OR PENAL DAMAGES, PARTICULAR OR MISCELLANEOUS DAMAGES OR FOR DEMANDS OR INDEMNITY CLAIMS FOR REDUCED PROFITS OR LOSSES. THIS SHALL ALSO APPLY IN THE CASE OF A REPRESENTATIVE OF WACOM BEING PREVIOUSLY AWARE OF THE POSSIBILITY OF SUCH LOSSES, DAMAGES, CLAIMS OR COSTS, OR DEMANDS FROM THIRD PARTIES.

The existing limitations on liability shall not apply in the case of the assumption of explicit guarantees, or in case of fraudulent behaviour on the part of WACOM, nor for damages arising from wilful or grossly negligent behaviour on the part of WACOM, from damages leading to loss of life, personal injury or sickness or in the case of binding legal provisions. For slight negligence, WACOM and its suppliers shall only be liable in the event of a breach of essential contractual obligations. Liability when such an essential contractual obligation is breached is, however, limited to damages typical to this type of contract, which WACOM must have determined at the conclusion of the contract based on the known risks and circumstances at that time. Claims for reduced profits or expenses saved, indemnity claims from third parties or claims for any other direct or consequential damages still cannot be asserted in this case.

The laws of the Federal Republic of Germany shall apply to this agreement. However, the applicability of the United Nations Convention on Contracts for the International Sale of Goods is explicitly excluded. Krefeld is the sole place of jurisdiction for all claims arising from this contractual relationship and all disputes between the parties resulting from the formation, handling or termination of the contractual relationship, provided that the customer is a trader, a legal entity under public law or a special fund under public law.

The jurisdiction agreement shall also apply for customers who do not have a general place of jurisdiction in Germany. The jurisdiction agreement shall not apply if, due to legal provisions, a different sole place of jurisdiction must be established for the case. Furthermore, WACOM is authorised to file a lawsuit against the headquarters of the customer.

This licence constitutes the entire contractual agreement between the parties. It overrides all other verbal and written contracts and agreements and may only be altered by means of a written and signed contract. Should one of the provisions of these licence conditions be or become void, the validity of the other provisions shall not be affected, in full or in part. Should a provision be invalid, the legally permissible regulation most closely resembling the invalid regulation shall apply in its place.

LIMITED WARRANTY

WACOM guarantees to you, as the initial purchaser, that the product hardware, when used as intended, will remain free from material defects and processing errors for a warranty period of TWO (2) YEARS and Cintiq products shall be guaranteed for a warranty period of THREE (3) YEARS, commencing from the purchase date and provided that the product was unused at the time of purchase. Defects in wear parts (e.g. pen tips) resulting from normal wear and tear are exempt from the warranty. Furthermore, WACOM guarantees that the data carriers delivered with the product are free from material defects and processing errors for a period of SIX (6) MONTHS from the date of purchase.

If the product-excluding any software-is discovered to be faulty it must be returned immediately to the place of purchase in its original packaging within the warranty period together with your name, address and telephone number, a description of the problem and a copy of the original receipt. The customer shall be liable for any possible damage or loss of the product during transit for this purpose. Under the provisions of this warranty, WACOM only undertakes to repair or replace the faulty product or parts at its own discretion, in cases where defects are proven and the product is sent within the warranty period.

WACOM is not obligated to repair or replace the product if: (a) the damage to the product results from any accident, misuse, improper use, negligence or unauthorised alteration or repair; (b) the product was not handled or stored according to the instructions provided by WACOM; (c) the damage resulted from normal wear and tear; or d) the serial number affixed by WACOM has been removed or rendered unintelligible.

If, when a claim made under this warranty is checked, it emerges that it is outside the permitted time period or is not covered by the warranty or that the product is not faulty, the costs of any checks or repairs must be borne by the customer.

Any descriptions, drawings, specifications, samples, models, notifications or similar material provided in connection with the purchase of the product cannot be taken as an explicit guarantee that the product corresponds to or fulfils the customer's requirements.

If this product is faulty, the purchaser shall be entitled to assert legal claims against the vendor for liability due to defects. These legal rights against the vendor are not limited by the existing warranty. The warranty grants the customer many additional rights under the conditions stipulated in this text.

This limited warranty shall apply if the registered office of the vendor is in the EU or in Iceland, Norway, Jersey, Switzerland, Russia, Ukraine, Croatia, Serbia, Tunisia, Turkey, Syria, Lebanon, Jordan, Israel, Egypt, United Arab Emirates, Iran or South Africa.

The granting of this limited warranty is subject to the laws of the Federal Republic of Germany. However, the applicability of the United Nations Convention on Contracts for the International Sale of Goods is explicitly excluded. Krefeld is the sole place of jurisdiction for all claims arising from this contractual relationship and all disputes between the parties resulting from the formation, handling or termination of the contractual relationship, provided that the customer is a trader, a legal entity under public law or a special fund under public law.

The jurisdiction agreement shall also apply for customers who do not have a general place of jurisdiction in Germany. The jurisdiction agreement shall not apply if, due to legal provisions, a different sole place of jurisdiction must be established for the case. Furthermore, WACOM is authorised to file a lawsuit against the headquarters of the customer.

Should one of the provisions of these limited warranty conditions be or become void, the validity of the other provisions shall not be affected, in full or in part. Should a provision be invalid, the legally permissible regulation most closely resembling the invalid regulation shall apply in its place.

If you have any questions about this agreement, or would like to contact WACOM for another reason, please contact us by post at this address:

WACOM Europe GmbH
Europark Fichtenhain A9
47807 Krefeld
GERMANY

CINTIQ EXCHANGE POLICY

(EUROPE, AFRICA AND MIDDLE EAST)

Should your Cintiq Interactive Pen Display become defective during the warranty period, Wacom Europe GmbH offers an exchange program. Please follow the procedure described below and note the restrictions:

- Note: The Cintiq exchange program can only be offered for countries of the European Union with the exception of Malta, Cyprus, the Canary Islands, and the French Overseas Territories.
- Note: You must have registered your Cintiq Interactive Pen Display at Wacom Europe GmbH if you want to take advantage of the exchange program.
- If you believe your Cintiq Interactive Pen Display is defective, please contact our Technical Support Staff (see section Support Staff in this manual). Please have the serial number of the defective unit, an error description and a copy of your original invoice at hand.
- If our support staff agrees that your Cintiq is defective, you will be asked to give your address for picking up the defective unit.
- You will receive a refurbished Cintiq display unit in exchange for your defective unit.
- Note: The delivery time for the exchange unit varies between 2 and 5 work days, depending on the country it is shipped to. Pick-up service of the defective unit may be separate from the delivery of the exchange unit!
- Note: You will not get back the very same unit that you handed in! Should you prefer to get back the very same unit, please send in your defective Cintiq directly to your nearest Wacom office, or ask your local dealer or distributor.
- Note: Wacom Europe GmbH reserves the right to invoice for shipping, checking and refurbishing the sent-in Cintiq unit if a copy of the original invoice or the error description is missing, or if they do not correspond with the sent-in unit.
- Note: Wacom Europe GmbH reserves the right to invoice for the exchange unit if the defective unit has not arrived at Wacom Europe GmbH headquarters within 7 days after delivery of the exchange unit.

In any case you can send in your defective Cintiq to any Wacom office for repair, either directly or through your dealer or distributor, however the fast exchange program is only available as described above.

Note: Wacom Europe GmbH reserves the right to change or cancel this service for all or some regions without further notice.

This page intentionally left blank.

WACOM TECHNOLOGY CORPORATION

1311 SE Cardinal Court
Vancouver, WA 98683

U.S.A.

Telephone: +1.360.896.9833

Fax: +1.360.896.9724

WACOM EUROPE GMBH

Europark Fichtenhain A9
47807 Krefeld

Germany

Telephone: +49.(0)2151.3614.0

Fax: +49.(0)2151.3614.111

**WACOM CO., LTD.
JAPAN MARKETING AND SALES DIVISION**

Harmony Tower 21F, 1-32-2 Hon-Cho
Nakano-Ku, Tokyo 164-0012

Japan

Internet: <http://tablet.wacom.co.jp>

**WACOM CO., LTD.
ASIA PACIFIC MARKETING
AND SALES DIVISION**

Harmony Tower 18F, 1-32-2 Hon-Cho,
Nakano-Ku, Tokyo 164-0012

Japan

Telephone: +81.3.5309.1513

Fax: +81.3.5309.1514

WACOM CHINA CORPORATION

Unit 2807, 28th Floor, SK Tower
No 6 Jia, Jianguomenwai Avenue,
Beijing, 100022, China

Internet: <http://www.wacom.com.cn>

WACOM KOREA CO., LTD.

25th Floor DMC iaan Sangam 2nd Complex, 1653
Sangam-dong, Mapo-gu, Seoul, Korea, 121-270

Telephone: +82.2.557.3894

Fax: +82.2.557.3895

WACOM AUSTRALIA PTY. LTD.

Unit 8, Stage 1 Cumberland Green
2-8 South Street Rydalmere
NSW 2116 Australia

Telephone: +61.2.9422.6700

Fax: +61.2.9420.2272

WACOM SINGAPORE PTE. LTD.

3 Bishan Place,
CPF Bishan Building #06-08
Singapore 579838

Telephone: +65.6258.8640

Fax: +65.6258.8697

WACOM TAIWAN INFORMATION CO., LTD.

Suite 605, 6th floor, No. 205 Tun-Hwa North Road
Taipiei, 105 Taiwan

Telephone: +886.2.2712.2675

Fax: +886.2.2712.9789

Cintiq® 12WX

Installation Guide & Hardware Manual