

Panasonic®

Operating Instructions

Blu-ray Disc Player

Model No. **DMP-BD80**
DMP-BD60

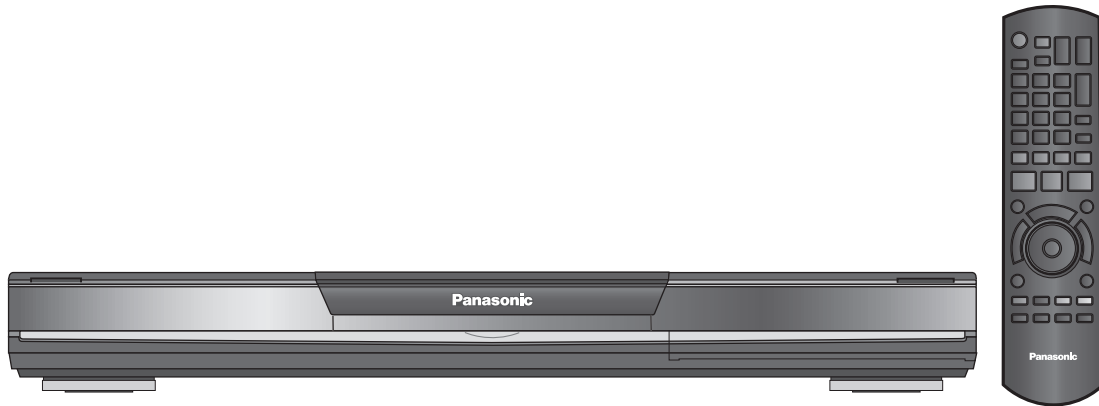

The illustration shows the image of DMP-BD80.

Dear customer

Thank you for purchasing this product.

For optimum performance and safety, please read these instructions carefully.

Before connecting, operating or adjusting this product, please read the instructions completely.

Please keep this manual for future reference.

Note: "EB" on the packaging indicates the United Kingdom.



BD-Video



HDMI
HIGH-DEFINITION MULTIMEDIA INTERFACE

VIERA
Link



AVCHD™

Java
POWERED

Region management information

BD-Video

This unit plays BD-Video marked with labels containing the region code B.

Example:



DVD-Video

This unit plays DVD-Video marked with labels containing the region number "2" or "ALL".

Example:



Caution for AC Mains Lead



(For the United Kingdom and Republic of Ireland)

For your safety, please read the following text carefully.

This appliance is supplied with a moulded three pin mains plug for your safety and convenience.

A 5-ampere fuse is fitted in this plug.

Should the fuse need to be replaced please ensure that the replacement fuse has a rating of 5-ampere and that it is approved by ASTA or BSI to BS1362.

Check for the ASTA mark  or the BSI mark  on the body of the fuse.

If the plug contains a removable fuse cover you must ensure that it is refitted when the fuse is replaced.

If you lose the fuse cover the plug must not be used until a replacement cover is obtained.

A replacement fuse cover can be purchased from your local dealer.

CAUTION!

IF THE FITTED MOULDED PLUG IS UNSUITABLE FOR THE SOCKET OUTLET IN YOUR HOME THEN THE FUSE SHOULD BE REMOVED AND THE PLUG CUT OFF AND DISPOSED OF SAFELY. THERE IS A DANGER OF SEVERE ELECTRICAL SHOCK IF THE CUT OFF PLUG IS INSERTED INTO ANY 13-AMPERE SOCKET.

If a new plug is to be fitted please observe the wiring code as stated below. If in any doubt please consult a qualified electrician.

IMPORTANT

The wires in this mains lead are coloured in accordance with the following code:

Blue: Neutral, Brown: Live.

As these colours may not correspond with the coloured markings identifying the terminals in your plug, proceed as follows:

The wire which is coloured Blue must be connected to the terminal which is marked with the letter N or coloured Black or Blue. The wire which is coloured Brown must be connected to the terminal which is marked with the letter L or coloured Brown or Red.

WARNING: DO NOT CONNECT EITHER WIRE TO THE EARTH TERMINAL WHICH IS MARKED WITH THE LETTER E, BY THE EARTH SYMBOL  OR COLOURED GREEN OR GREEN/YELLOW.

THIS PLUG IS NOT WATERPROOF—KEEP DRY.

Before use

Remove the connector cover.

How to replace the fuse

The location of the fuse differ according to the type of AC mains plug (figures A and B). Confirm the AC mains plug fitted and follow the instructions below.

Illustrations may differ from actual AC mains plug.

1. Open the fuse cover with a screwdriver.

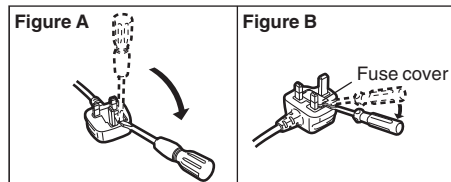

2. Replace the fuse and close or attach the fuse cover.

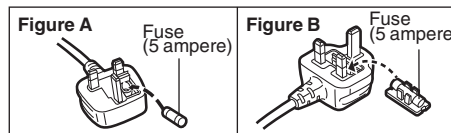

CAUTION!

THIS PRODUCT UTILIZES A LASER. USE OF CONTROLS OR ADJUSTMENTS OR PERFORMANCE OF PROCEDURES OTHER THAN THOSE SPECIFIED HEREIN MAY RESULT IN HAZARDOUS RADIATION EXPOSURE. DO NOT OPEN COVERS AND DO NOT REPAIR YOURSELF. REFER SERVICING TO QUALIFIED PERSONNEL.

WARNING:

TO REDUCE THE RISK OF FIRE, ELECTRIC SHOCK OR PRODUCT DAMAGE,

- DO NOT EXPOSE THIS APPARATUS TO RAIN, MOISTURE, DRIPPING OR SPLASHING AND THAT NO OBJECTS FILLED WITH LIQUIDS, SUCH AS VASES, SHALL BE PLACED ON THE APPARATUS.
- USE ONLY THE RECOMMENDED ACCESSORIES.
- DO NOT REMOVE THE COVER (OR BACK); THERE ARE NO USER SERVICEABLE PARTS INSIDE. REFER SERVICING TO QUALIFIED SERVICE PERSONNEL.

CAUTION!

- DO NOT INSTALL OR PLACE THIS UNIT IN A BOOKCASE, BUILT-IN CABINET OR IN ANOTHER CONFINED SPACE. ENSURE THE UNIT IS WELL VENTILATED. TO PREVENT RISK OF ELECTRIC SHOCK OR FIRE HAZARD DUE TO OVERHEATING, ENSURE THAT CURTAINS AND ANY OTHER MATERIALS DO NOT OBSTRUCT THE VENTILATION VENTS.
- DO NOT OBSTRUCT THE UNIT'S VENTILATION OPENINGS WITH NEWSPAPERS, TABLECLOTHS, CURTAINS, AND SIMILAR ITEMS.
- DO NOT PLACE SOURCES OF NAKED FLAMES, SUCH AS LIGHTED CANDLES, ON THE UNIT.
- DISPOSE OF BATTERIES IN AN ENVIRONMENTALLY FRIENDLY MANNER.

CAUTION

Danger of explosion if battery is incorrectly replaced. Replace only with the same or equivalent type recommended by the manufacturer. Dispose of used batteries according to the manufacturer's instructions.

This product may receive radio interference caused by mobile telephones during use. If such interference is apparent, please increase separation between the product and the mobile telephone.

The socket outlet shall be installed near the equipment and easily accessible. The mains plug of the power supply cord shall remain readily operable. To completely disconnect this apparatus from the AC Mains, disconnect the power supply cord plug from AC receptacle.

THIS UNIT IS INTENDED FOR USE IN MODERATE CLIMATES.

Safety precautions

Placement

Set the unit up on an even surface away from direct sunlight, high temperatures, high humidity, and excessive vibration. These conditions can damage the cabinet and other components, thereby shortening the unit's service life. Do not place heavy items on the unit.

Voltage

Do not use high voltage power sources. This can overload the unit and cause a fire. Do not use a DC power source. Check the source carefully when setting the unit up on a ship or other place where DC is used.

AC mains lead protection

Ensure the AC mains lead is connected correctly and not damaged. Poor connection and lead damage can cause fire or electric shock. Do not pull, bend, or place heavy items on the lead. Grasp the plug firmly when unplugging the lead. Pulling the AC mains lead can cause electric shock. Do not handle the plug with wet hands. This can cause electric shock.

Foreign matter

Do not let metal objects fall inside the unit. This can cause electric shock or malfunction. Do not let liquids get into the unit. This can cause electric shock or malfunction. If this occurs, immediately disconnect the unit from the power supply and contact your dealer. Do not spray insecticides onto or into the unit. They contain flammable gases which can ignite if sprayed into the unit.

Service

Do not attempt to repair this unit by yourself. If sound is interrupted, indicators fail to light, smoke appears, or any other problem that is not covered in these instructions occurs, disconnect the AC mains lead and contact your dealer or an authorized service center. Electric shock or damage to the unit can occur if the unit is repaired, disassembled or reconstructed by unqualified persons.

Extend operating life by disconnecting the unit from the power source if it is not to be used for a long time.

Unit and media care

Disc and card handling

Clean discs

DO **DO NOT**



Wipe with a damp cloth and then wipe dry.

Disc and card handling precautions

- Handle discs by the edges to avoid inadvertent scratches or fingerprints on the disc.
- Do not attach labels or stickers to discs (This may cause disc warping, rendering it unusable).
- Do not write on the label side with a ball-point pen or other writing instrument.
- Do not use record cleaning sprays, benzene, thinner, static electricity prevention liquids or any other solvent.
- Do not use scratch-proof protectors or covers.
- Clean any dust, water, or foreign matter from the terminals on the rear side of the card.
- Do not use the following discs:
 - Discs with exposed adhesive from removed stickers or labels (rented discs etc).
 - Discs that are badly warped or cracked.
 - Irregularly shaped discs, such as heart shapes.

Maintenance

Clean this unit with a soft, dry cloth

- Never use alcohol, paint thinner or benzene to clean this unit.
- Before using chemically treated cloth, carefully read the instructions that came with the cloth.

Observe the following points to ensure continued listening and viewing pleasure.

Dust and dirt may adhere to the unit's lens over time, making it impossible to play discs.

Use the lens cleaner (not included) about once every year, depending on frequency of use and the operating environment. Carefully read the lens cleaner's instructions before use.

Lens cleaner: RP-CL720E

- This lens cleaner is not for sale in Germany and may not be for sale depending on the region.
- This lens cleaner is sold as specific for DIGA, but can be used without problem on this unit as well.

To dispose or transfer this unit

This unit may record information of your operating procedures. If you discard this unit either by disposal or transfer, then follow the procedures to return all the settings to the factory presets to delete the recorded information. (⇒ 38, "To return to the factory preset")

- When BD-Video is played back, the operation history may be recorded in the memory of this unit. The recorded contents differ depending on the disc.

Information for Users on Collection and Disposal of Old Equipment and used Batteries



These symbols on the products, packaging, and/or accompanying documents mean that used electrical and electronic products and batteries should not be mixed with general household waste.

For proper treatment, recovery and recycling of old products and used batteries, please take them to applicable collection points, in accordance with your national legislation and the Directives 2002/96/EC and 2006/66/EC.

By disposing of these products and batteries correctly, you will help to save valuable resources and prevent any potential negative effects on human health and the environment which could otherwise arise from inappropriate waste handling.

For more information about collection and recycling of old products and batteries, please contact your local municipality, your waste disposal service or the point of sale where you purchased the items.

Penalties may be applicable for incorrect disposal of this waste, in accordance with national legislation.



For business users in the European Union

If you wish to discard electrical and electronic equipment, please contact your dealer or supplier for further information.

[Information on Disposal in other Countries outside the European Union]

These symbols are only valid in the European Union. If you wish to discard these items, please contact your local authorities or dealer and ask for the correct method of disposal.



Note for the battery symbol (bottom two symbol examples):

This symbol might be used in combination with a chemical symbol. In this case it complies with the requirement set by the Directive for the chemical involved.

Cd

Table of contents

Getting started

Caution for AC Mains Lead	2
Safety precautions	2
Unit and media care	3
Accessory information	5
Using the remote control	5
Media (Disc, card and USB device) information	6
Connection	8
Control reference guide	11
Easy Setting	12
Setting the television and amplifier/receiver operation	12
Network connection	13
Firmware updating	13
Network settings	14

Playback

Basic operation	16
Chapter playback	18
Playing HD Video or SD Video	18
Enjoying BD-LIVE or BONUSVIEW in BD-Video	19
Enjoying High Bit rate Audio and Video	20
Playing music	21
Playing still pictures	22
Playing DivX® videos	24
Enjoying VIERA CAST™	25
Showing FUNCTIONS menu	25
Changing settings with the on-screen menu	26
Linked operations with the TV (VIERA Link “HDMI Control™”)	28

Settings

Changing the unit's settings	29
------------------------------------	----

Reference

About MP3/JPEG/DivX files	34
Messages	36
Troubleshooting guide	38
Glossary	42
Specifications	44
Index	Back cover

About descriptions in these operating instructions

● These operating instructions are applicable to models DMP-BD80 and DMP-BD60. Unless otherwise indicated, illustrations in these operating instructions are of DMP-BD80.



BD80 : indicates features applicable to DMP-BD80 only.

BD60 : indicates features applicable to DMP-BD60 only.

Accessory information

Please check and identify the supplied accessories. Use numbers indicated in parentheses when asking for replacement parts.
(Product numbers correct as of January 2009. These may be subject to change.)

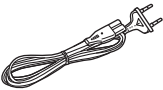
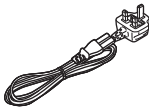

<input type="checkbox"/>  1 Remote control (N2QAYB000380)	<input type="checkbox"/>  1 Audio/Video cable (K2KA2BA00003)	<input type="checkbox"/>  2 Batteries for remote control (R6/LR6, AA)
<input type="checkbox"/> <div style="display: flex; justify-content: space-around;"> <div style="width: 45%;"> <p>For Continental Europe</p>  1 AC mains lead (RJA0043-1C) </div> <div style="width: 45%;"> <p>For the United Kingdom and Republic of Ireland</p>  1 AC mains lead (K2CT3CA00004) </div> </div> <p>● For use with this unit only. Do not use it with other equipment. Also, do not use cords for other equipment with this unit.</p>		

For the United Kingdom and Republic of Ireland

■ Sales and Support Information

Customer Care Centre

- For customers within the UK: 0844 844 3852
- For customers within the Republic of Ireland: 01 289 8333
- Visit our website for product information
- E-mail: customer.care@panasonic.co.uk

Direct Sales at Panasonic UK

- For customers: 0844 844 3856
- Order accessory and consumable items for your product with ease and confidence by phoning our Customer Care Centre Monday–Thursday 9:00 a.m.–5:30 p.m., Friday 9:30 a.m.–5:30 p.m. (Excluding public holidays)
- Or go on line through our Internet Accessory ordering application at www.panasonic.co.uk.
- Most major credit and debit cards accepted.
- All enquiries transactions and distribution facilities are provided directly by Panasonic UK Ltd.
- It couldn't be simpler!
- Also available through our Internet is direct shopping for a wide range of finished products, take a browse on our website for further details.

Interested in purchasing an extended guarantee?

Please call 0870 240 6284 or visit our website www.panasonic.co.uk/guarantee.

Using the remote control

Batteries

Insert so the poles (+ and –) match those in the remote control.
When closing the lid, insert it from the – (minus) side.

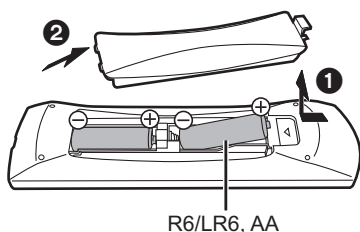

- Use alkaline or manganese batteries.
 - Do not mix old and new batteries.
 - Do not use different types at the same time.
 - Do not heat or expose to flame.
 - Do not leave the battery(ies) in an automobile exposed to direct sunlight for a long period of time with doors and windows closed.
 - Do not take apart or short circuit.
 - Do not attempt to recharge alkaline or manganese batteries.
 - Do not use batteries if the covering has been peeled off.
- Mishandling of batteries can cause electrolyte leakage which can damage items the fluid contacts and may cause a fire.
Remove batteries if the remote control is not going to be used for a long period of time. Store in a cool, dark place.

Use

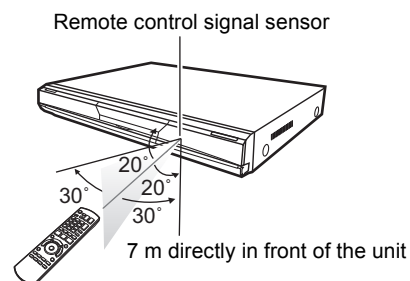





If you cannot operate the unit or other equipment using the remote control after changing the batteries, please re-enter the codes (⇒ 12, 41).

Media (Disc, card and USB device) information

Packaged discs

This chart shows the different type of retail/commercial discs you can use, and also includes the industry-standard logos that should appear on the discs and/or packaging.





Type of media/ Logo	Features	Indicated as
BD-Video 	High Definition (HD) movie and music discs • Discs supporting BD-Live (BD-ROM Profile 2) that allows interactive functions to be used when this unit is connected to the Internet in addition to the BONUSVIEW function.  • Discs supporting BONUSVIEW (BD-ROM Profile 1 version 1.1/Final Standard Profile) that allows Picture-in-Picture functions to be used. BONUS VIEW™	BD-V

Type of media/ Logo	Features	Indicated as
DVD-Video  	High quality movie and music discs	DVD-V
CD 	Compact Discs (CD's) that contain audio and music • Operation and sound quality of CDs that do not conform to CD-DA specifications (copy control CDs, etc.) cannot be guaranteed.	CD

Recorded discs

This chart shows the different type of discs recorded with other devices that you can use.

Finalized This mark means you must finalize the disc with the DVD recorder, etc. before playback. For details about finalizing, refer to the operating instructions for your equipment.

Type of media/ Logo	Formats	Indicated as
BD-RE 	• Version 3 of the BD-RE Recording Format • JPEG format	BD-V JPEG
BD-R 	• Version 2 of the BD-R Recording Format	BD-V
DVD-RAM 	• Version 1.1 of the DVD Video Recording Format • JPEG format • AVCHD format	DVD-VR JPEG AVCHD
DVD-R/RW Finalized  	• DVD-Video Format • Version 1.1 of the DVD Video Recording Format • MP3 format (DVD-RW is not supported) • JPEG format (DVD-RW is not supported) • AVCHD format • DivX format (DVD-RW is not supported)	DVD-V DVD-VR MP3 JPEG AVCHD DivX

Type of media/ Logo	Formats	Indicated as
DVD-R DL Finalized 	• DVD-Video Format • Version 1.2 of the DVD Video Recording Format • MP3 format • JPEG format • AVCHD format • DivX format	DVD-V DVD-VR MP3 JPEG AVCHD DivX
+R/+RW/+R DL Finalized	• +VR (+R/+RW Video Recording) Format • AVCHD format	DVD-V AVCHD
CD-R/RW Finalized	• CD-DA format • MP3 format • JPEG format • DivX format	CD MP3 JPEG DivX

- It may not be possible to play the above discs in some cases due to the type of discs, the condition of the recording, the recording method and how the files were created.
- When a disc recorded in the AVCHD format is being played, the video may be paused for a few seconds at portions spliced, due to deletion or editing.

About playback compatibility for BD-R and BD-RE with high definition recordings of high definition broadcasts

With DMP-BD60/80 purchased in the below countries, it is possible to playback discs with recordings of the high definition broadcasts listed to the right which were recorded with Panasonic Blu-ray Disc recorders.

As high definition broadcasts are a new technology, areas confirmed as of March 2009 are as below.

Country	Digital Broadcast
France	TNT HD (Compatible models DMP-BD60EF, DMP-BD80EG)
United Kingdom	freesat (Compatible models DMP-BD60EB, DMP-BD80EB)

SD cards

This chart shows the different type of cards recorded with other devices that you can use.

Type of media	Formats	Indicated as
SD Memory Card* (from 8 MB to 2 GB) SDHC Memory Card (from 4 GB to 32 GB)	<ul style="list-style-type: none"> • JPEG format • AVCHD format • MPEG2 format 	JPEG AVCHD MPEG2

* Including miniSD Card and microSD Card
 In these operating instructions, the cards shown in the table (⇒ above) are comprehensively called SD cards.

- A miniSD Card and a microSD Card must be used with the attached adaptor that comes with the card.
- When using from 4 GB to 32 GB SD cards, only SD cards that display the SDHC logo can be used.
- This unit is compatible with SD Memory Cards that meet SD Card Specifications FAT12 and FAT16 formats, as well as SDHC Memory Cards in FAT32 format.



- Useable memory is slightly less than the card capacity.
- If the SD card is formatted on a PC, you may not be able to use it on this unit.
- We recommend using a Panasonic SD card. Please confirm the latest information on the following website. <http://panasonic.co.jp/pavc/global/cs> (This site is in English only.)
- Keep the Memory Card out of reach of children to prevent swallowing.
- When a card recorded in the AVCHD format is being played, the video may be paused for a few seconds at portions spliced, due to deletion or edition.
- Switch the write-protect switch to the "LOCK" position to protect the content from accidental erasure.

USB device

This unit can playback pictures by connecting the USB memory recorded with a PC or similar in following formats, and Panasonic digital cameras connected via USB cable.

Type of media	Formats	Indicated as
USB device	<ul style="list-style-type: none"> • MP3 format • JPEG format • DivX format 	MP3 JPEG DivX

Compatible USB devices

- USB devices which are defined as USB mass storage class.
 - USB devices that support USB 1.0/1.1 and USB 2.0 Full Speed/High Speed.
- USB devices of up to 128 GB can be used.
- USB devices that support bulk only transfer.
 - CBI (Control/Bulk/Interrupt) is not supported.
- Digital Cameras which require additional programme installation when connected to a PC are not supported.
- MTP (Media Transport Protocol) device is not supported.
- A multi-port USB card reader is not supported.

File system

- FAT12, FAT16 and FAT32 file systems are supported.
- UDF/NTFS/exFAT file system is not supported.
- Depending on the sector size, some files may not work.
- Only the first partition on USB devices with multi-partition is supported.

Despite meeting the conditions mentioned above, there may be USB device that cannot be used with this unit.

This unit does not support USB device charging.

Discs that cannot be played

- BD-RE with the cartridge
- 2.6 GB and 5.2 GB DVD-RAM
- 3.95 GB and 4.7 GB DVD-R for Authoring
- DVD-RAM that cannot be removed from their cartridges
- Version 1.0 of DVD-RW
- DVD-ROM, CD-ROM, CDV, SACD, Photo CD, MV-Disc and PD
- DVD-Audio
- Video CD and SVCD
- WMA discs
- HD DVD
- Other discs that are not specifically supported

Connection

- Do not place the unit on amplifiers/receiver or equipment that may become hot. The heat can damage the unit.
- **Do not connect through the video cassette recorder.** Due to copy guard protection, the picture may not be displayed properly.
- Turn off all equipment before connection and read the appropriate operating instructions.

- **Non-HDMI-compliant cables cannot be utilized.**
- **Please use High Speed HDMI Cables that have the HDMI logo (as shown on the cover). It is recommended that you use Panasonic's HDMI cable.**
Recommended part number:
RP-CDHG10 (1.0 m), RP-CDHG15 (1.5 m), RP-CDHG20 (2.0 m), RP-CDHG30 (3.0 m), RP-CDHG50 (5.0 m), etc.
- This unit incorporates HDMI (Deep Colour, x.v.Colour™, High Bit rate Audio) technology. (⇒ 42, 43)
- When outputting 1080p signal, please use HDMI cables 5.0 meters or less.

For the United Kingdom and Republic of Ireland only

BE SURE TO READ THE CAUTION FOR THE AC MAINS LEAD ON PAGE 2 BEFORE CONNECTION.

Connecting to a television

The image quality improves in a sequence of connections **C**, **B**, **A**, given below.

A Connecting to HDMI AV OUT terminal

You can enjoy high quality, digital video and audio.

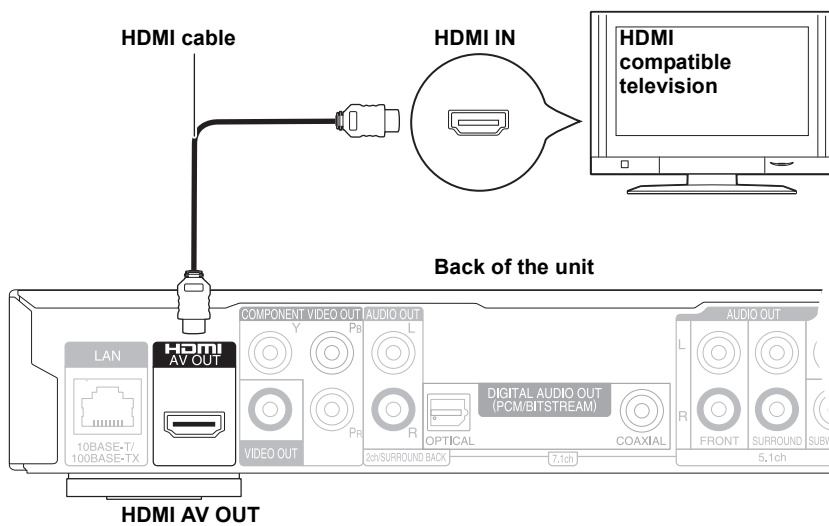

NECESSARY SETTINGS

- "HDMI Video Mode" and "HDMI Audio Output": "On" (⇒ 31)



To enjoy a richer sound

- Use connections **D**, **E**, **F** or **G** (⇒ 9–10) additionally.
In case of the connection **E**, **F** or **G**, set "HDMI Audio Output" to "Off" (⇒ 31)

With this connection, you can use VIERA Link "HDAVI Control" (⇒ 28).

B Connecting to COMPONENT VIDEO OUT terminal

You can enjoy high definition images by connecting to a component video terminals that supports 720p (750p) and 1080i (1125i) signals.

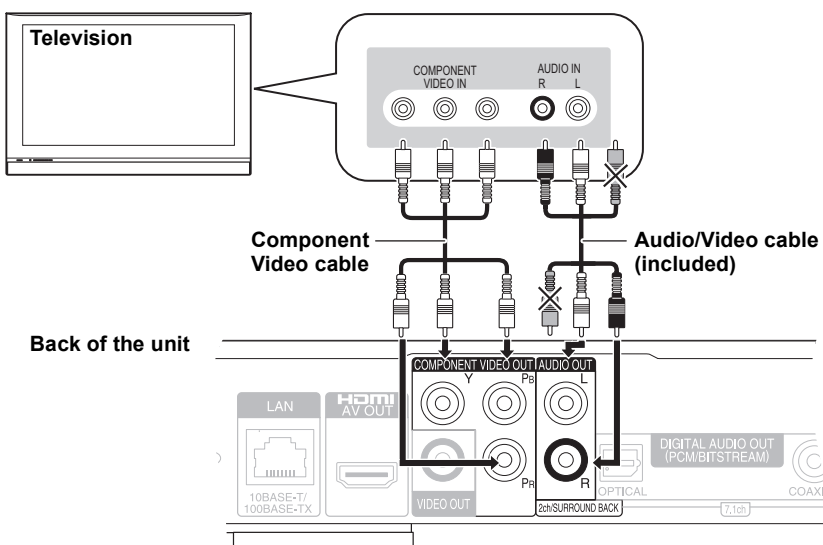

NECESSARY SETTINGS

- **BD80** "Analog Audio Output": "2ch (Downmix) + 5.1ch" (⇒ 31)
- **BD80** Set "High Clarity Sound" on the on-screen menu to "Off" (⇒ 27). (Otherwise, the video will not be output.)

- Connect terminals of the same color.
- Unplug the yellow plug of Audio/Video cable.
- The video output resolution is restricted to "576p/480p" when DVD-Video discs, DivX and BD-Video discs recorded at a rate of 50 field per second are output from the COMPONENT VIDEO OUT terminals.



To enjoy a richer sound

- Use connections **D**, **E**, **F** or **G** (⇒ 9–10) additionally.
(Unplug the red and white plugs.)

To enjoy high definition/progressive video

- Connect to a television that supports 576p/480p or higher.
- Set "Component Resolution" to "576p/480p", "720p" or "1080i". (⇒ 31)
- If this unit is connected to an amplifier/receiver, etc. via an HDMI cable with "HDMI Video Mode" to "On" (⇒ 31), the video will be fixed to 576i/480i.

C Connecting to VIDEO OUT terminal

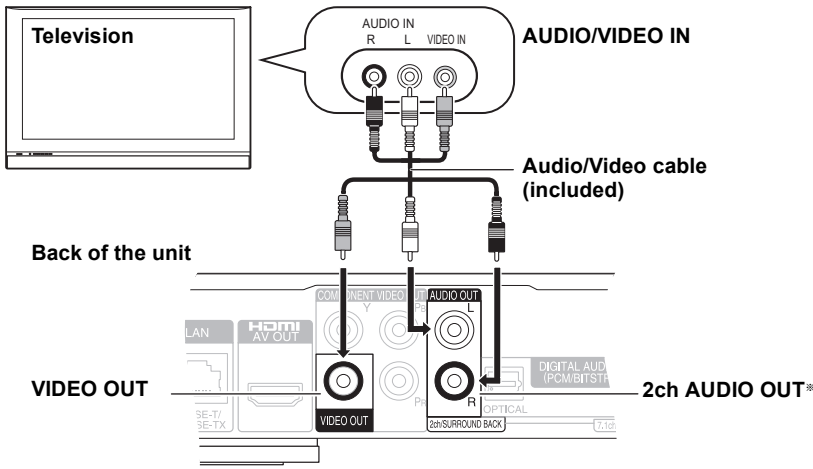

NECESSARY SETTINGS

- **BD80** "Analog Audio Output": "2ch (Downmix) + 5.1ch" (⇒ 31)
- **BD80** Set "High Clarity Sound" on the on-screen menu to "Off" (⇒ 27). (Otherwise, the video will not be output.)

- Connect terminals of the same color.
- High definition video cannot be output with this connection. Use connection **A** or **B** (⇒ 8) for high definition video.



- * With audio cables, connect the AUDIO OUT terminals to the two-channel audio input terminals of an analog amplifier/receiver or system component in place of a television to enjoy stereo sound.

To enjoy a richer sound

- Use connections **D**, **E**, **F** or **G** (⇒ 9–10) additionally. (Unplug the red and white plugs.)

Connecting an amplifier/receiver

D Connecting to HDMI AV OUT terminal

When connected to a compatible amplifier/receiver, you can enjoy surround sound recorded with Dolby Digital Plus, Dolby TrueHD or DTS-HD.

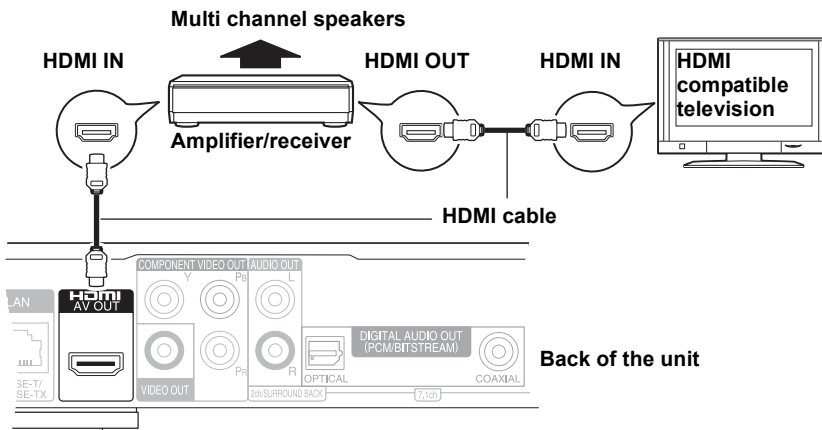

NECESSARY SETTINGS

- "HDMI Video Mode" and "HDMI Audio Output": "On" (⇒ 31)
- "Digital Audio Output": Depending on the connected amplifier/receiver (⇒ 30)



With this connection, you can use VIERA Link "HDAVI Control" (⇒ 28).

- Enjoying High Bit rate Audio with 7.1ch speaker and 5.1ch speaker (⇒ 20)

E Connecting to 7.1ch AUDIO OUT terminal **BD80**

When connected to a compatible amplifier/receiver using the 7.1ch AUDIO OUT terminals, you can enjoy surround sound.

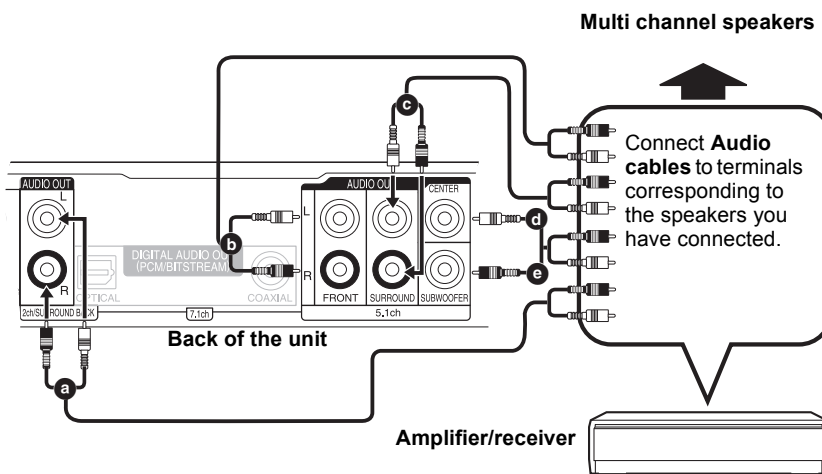

Cable connections

- a** Surround back speaker (L/R)
- b** Front speaker (L/R)
- c** Surround speaker (L/R)
- d** Center speaker
- e** Subwoofer



NECESSARY SETTINGS

- "Analog Audio Output": "7.1ch" (⇒ 31)
- Enjoying High Bit rate Audio with 7.1ch speaker and 5.1ch speaker (⇒ 20)

When connecting amplifier/receiver or other devices with HDMI AV OUT terminal

- "HDMI Audio Output" : "Off" (⇒ 31) (Otherwise, depending on the specifications of connected devices, the audio from AUDIO OUT terminal may be output as two channels only.)

When connecting a television with HDMI AV OUT terminal (⇒ 8, **A**).

- "HDMI Audio Output" : "Off" (⇒ 31) (Otherwise, the sound may not be output with the desired audio.)
- Depending on how the disc was recorded, the audio may not be output properly on the number of channels desired.

F Connecting to 5.1ch AUDIO OUT terminal **BD80**

When connected to a compatible amplifier/receiver using the 5.1ch AUDIO OUT terminals, you can enjoy surround sound.

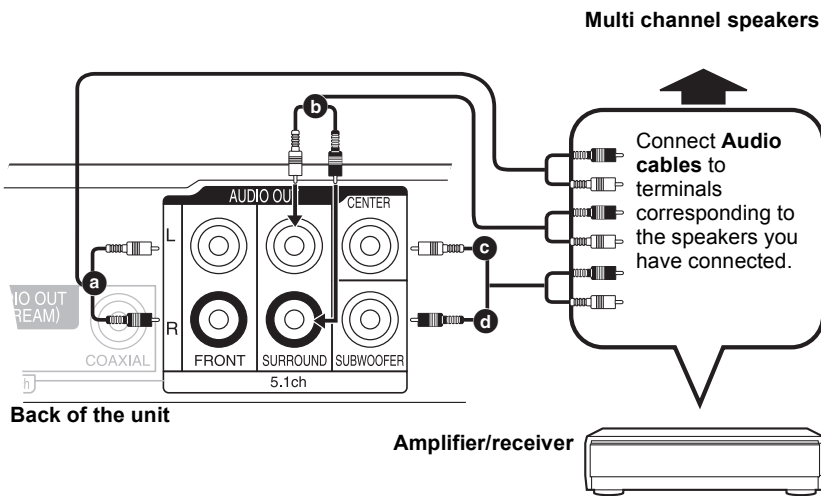

Cable connections

- a** Front speaker (L/R)
- b** Surround speaker (L/R)

- c** Center speaker
- d** Subwoofer



NECESSARY SETTINGS

- "Analog Audio Output": "2ch (Downmix) + 5.1ch" (⇒ 31)

- 7.1 channel disc is mixed down to 5.1 channel audio.
- Enjoying High Bit rate Audio with 7.1ch speaker and 5.1ch speaker (⇒ 20)

When connecting amplifier/receiver or other devices with HDMI AV OUT terminal

- "HDMI Audio Output": "Off" (⇒ 31)
(Otherwise, depending on the specifications of connected devices, the audio from AUDIO OUT terminal may be output as two channels only.)

When connecting a television with HDMI AV OUT terminal (⇒ 8, A).

- "HDMI Audio Output": "Off" (⇒ 31)
(Otherwise, the sound may not be output with the desired audio.)
- Depending on how the disc was recorded, the audio may not be output properly on the number of channels desired.

G Connecting to DIGITAL AUDIO OUT terminal

You can enjoy surround sound, when connected to an amplifier/receiver using the COAXIAL (**BD80**) or OPTICAL terminal.

With COAXIAL (**BD80**) or OPTICAL

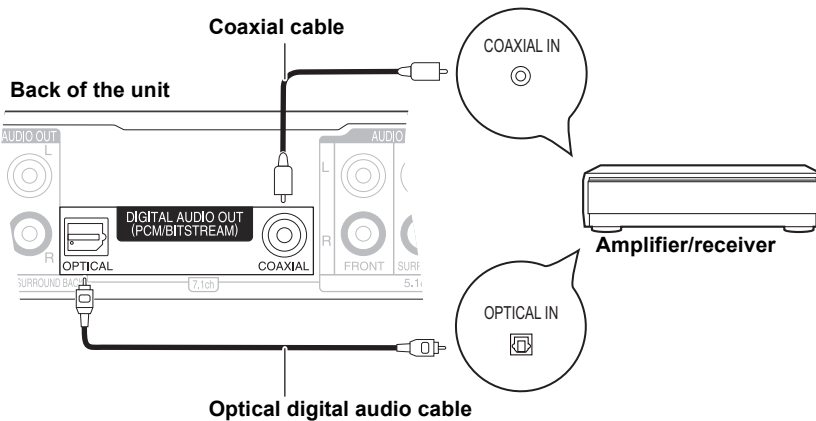

NECESSARY SETTINGS

- "Digital Audio Output": Depending on the connected amplifier/receiver (⇒ 30)

When connecting a television with HDMI AV OUT terminal (⇒ 8, A).

- "HDMI Audio Output": "Off" (⇒ 31)
(Otherwise, the sound may not be output with the desired audio.)

Connecting AC mains lead

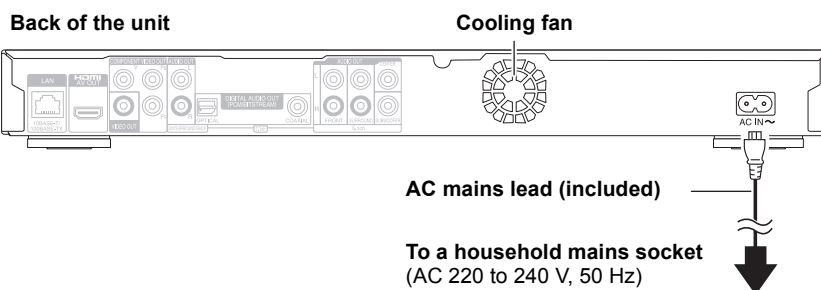

Connect only after all other connections are complete.



Conserving power

This unit consumes a small amount of power even when it is turned off ("Quick Start": "Off", less than 0.5 W). To save power when the unit is not to be used for a long time, unplug it from the household mains socket.

Control reference guide

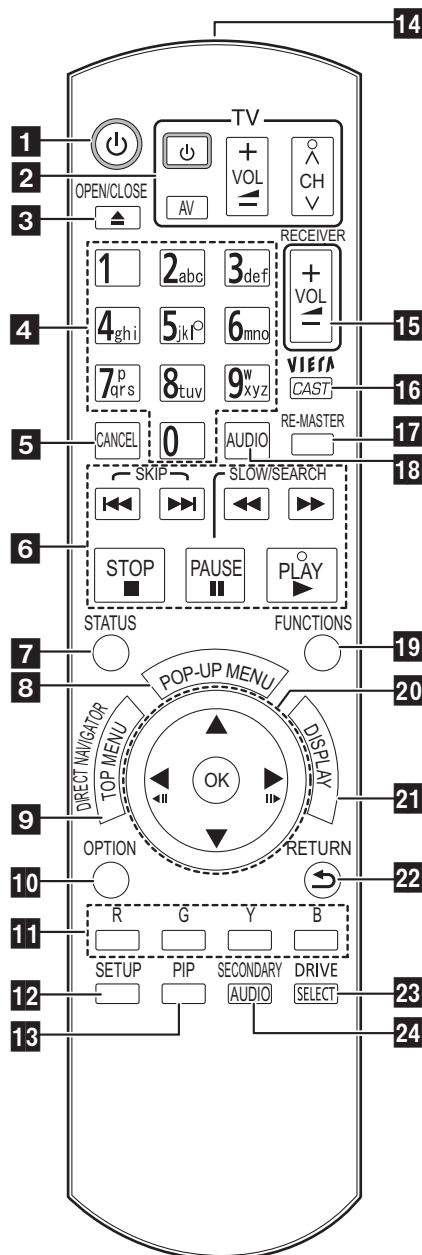

- 1** Turn the unit on and off (⇒ 12)
- 2** **TV operation buttons** (⇒ 12)
You can operate the TV through the unit's remote control.
[TV] : Turn the television on and off
[AV] : Switch the input select
[+ - VOL] : Adjust the volume
[^ v CH] : Channel select
- 3** Open or close the disc tray (⇒ 16)
- 4** Select title numbers, etc./Enter numbers or characters (⇒ 15, 17)
(The character buttons may be used when operating VIERA CAST contents. ⇒ 25)
- 5** Cancel
- 6** **Basic playback control buttons** (⇒ 16, 17)
- 7** Show status messages (⇒ 17)
- 8** Show Pop-up menu (⇒ 16)
- 9** Show Top menu/Direct Navigator (⇒ 16)
- 10** Show OPTION menu (⇒ 18)
- 11** These buttons are used when;
 - Operating a BD-Video disc that includes Java™ applications (BD-J). For more information about operating this kind of disc, please read the instructions that came with the disc.
 - Displaying "Title View" and "Album View" screens. (Only the [R] and [G] buttons, ⇒ 22)
 - Operating contents of VIERA CAST. (⇒ 25)
- 12** Show Setup menu (⇒ 29)
- 13** Switch on/off Secondary Video (Picture-in-picture) (⇒ 19)
- 14** Transmit the remote control signal
- 15** Adjust the volume of an amplifier/receiver through the unit's remote control.
- 16** Displays Home screen of VIERA CAST (⇒ 25)
- 17** Reproduce more natural audio (⇒ 18)
- 18** Select audio (⇒ 18)
- 19** Show FUNCTIONS menu (⇒ 25)
- 20** Selection/OK, Frame-by-frame (⇒ 17)
- 21** Show on-screen menu (⇒ 26)
- 22** Return to previous screen
- 23** Select drive (BD/DVD/CD, SD card or USB device) (⇒ 16)
- 24** Switch on/off Secondary Audio (⇒ 19)

CAUTION

Do not place objects in front of the unit. The disc tray may collide with objects when it is opened, and this may cause injury.

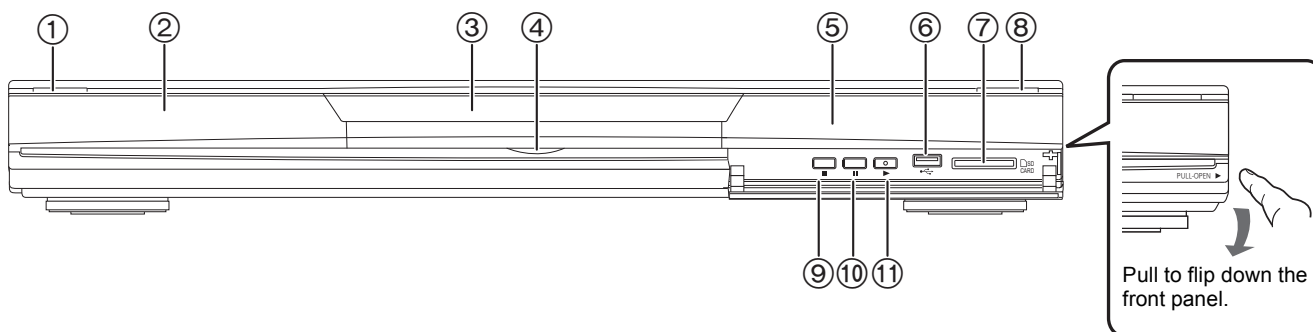

- 1** **Standby/on switch** (⏻/⏻) (⇒ 16)
Press to switch the unit from on to standby mode or vice versa. In standby mode, the unit is still consuming a small amount of power.
- 2** Display
- 3** Disc tray (⇒ 16)
- 4** **BD80** SD Card LED
• It is possible to set the LED to turn on/off. (⇒ 30, SD Card LED Control)
- 5** Remote control signal sensor (⇒ 5)
- 6** USB port (⇒ 16)
- 7** SD card slot (⇒ 16)

- 8** Open or close the disc tray (⇒ 16)
- 9** Stop (⇒ 17)
- 10** Pause (⇒ 17)
- 11** Start play (⇒ 16)

Rear panel terminals (⇒ 8–10, 13)

Disc indicator SD card indicator USB device indicator

The indicator blinks when reading data from a disc, a card or a USB device, or writing data to a card.

Easy Setting

After connecting your new player and pressing the standby/on button, a screen for the basic settings will appear.

Preparation

Turn on the television and select the appropriate video input on the television.

1 Press [⏻].

Setup screen appears.

- If this unit is connected to a Panasonic TV (VIERA) supporting HDAVI Control 2 or later via an HDMI cable, then the "On-Screen Language" and "TV Aspect" setting information on the TV are captured from the TV.

2 Follow the on-screen instructions and make the settings with [▲, ▼] and [OK].

"On-Screen Language", "TV Aspect", "Analog Audio Output" (**BD80**) and "Quick Start" are set. (⇒ 30 – 32)

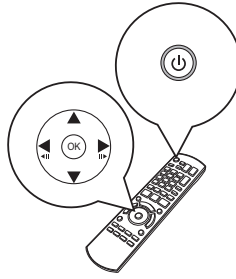

TIPS

- You can perform this setup anytime by selecting "Easy Setting" in the Setup menu. (⇒ 32)
- You can also change these settings individually. (⇒ 30 – 32)

Setting the television and amplifier/receiver operation

You can operate the TV or amplifier/receiver using the unit's remote control.

Point the remote control at the television or amplifier/receiver.

1 For televisions

Input the 2-digit code with the numbered buttons while pressing [⏻ TV].

For amplifiers/receivers

Input the 2-digit code with the numbered buttons while pressing [RECEIVER – VOL].

e.g., 01: [0] ⇒ [1]

2 Test by turning on the television or adjusting the volume of the amplifier/receiver.



NOTE

- If your television or amplifier/receiver brand has more than one code listed, select the one that allows correct operation.
- If your television or amplifier/receiver brand is not listed or if the code listed for them does not allow control of your television or amplifier/receiver, this remote control is not compatible with them. Use their remote control.

Brand	TV Code
Panasonic	01/02/03/04
AIWA	35
AKAI	27/30
BEIJING	33
BEKO	05/71/72/73/74
BENQ	58/59
BP	09
BRANDT	10/15
BUSH	05
CENTREX	66
CHANGHONG	69
CURTIS	05
DAEWOO	64/65
DESMET	05
DUAL	05
ELEMIS	05
FERGUSON	10/34
FINLUX	61
FISHER	21
FUJITSU	53
FUNAI	63/67
GOLDSTAR	05/50/51
GOODMANS	05
GRADIENTE	36
GRUNDIG	09
HIKONA	52
HITACHI	05/22/23/40/41
INNO HIT	05
IRRADIO	30
ITT	25
JINGXING	49
JVC	17/30/39/70
KDS	52
KOLIN	45
KONKA	62
LG	05/50/51
LOEWE	07/46
MAG	52
METZ	05/28
mitsubishi	05/19/20/47

Brand	TV Code
MIVAR	24
NEC	36
NOBLEX	33
NOKIA	25/26/27/60/61
NORDMENDE	10
OLEVIA	45
ONWA	30/39/70
ORION	05
PEONY	49/69
PHILCO	41/48/64
PHILIPS	05/06/46
PHONOLA	05
PIONEER	37/38
PROVIEW	52
PYE	05
RADIOLA	05
SABA	10
SALORA	26
SAMSUNG	32/42/43/65/68
SANSUI	05
SANYO	21/54/55/56
SCHNEIDER	05/29/30
SEG	05/69/75/76/77/78
SELECO	05/25
SHARP	18
SIEMENS	09
SINUDYNE	05
SONY	08
TCL	31/33/66/67/69
TELEFUNKEN	10/11/12/13/14
TEVION	52
TEX ONDA	52
THOMSON	10/15/44
TOSHIBA	16/57
WHITE	
WESTINGHOUSE	05
YAMAHA	18/41

Brand	Amplifier/Receiver Code
Panasonic	01/02/03
TECHNICS	35
ADCOM	62
AIWA	04/05/06/48/49
ALPINE	63
ARCAM	57/58
BOSE	07
DENON	08/09/10/11/50/51/52
HARMAN	12
KARDON	12
JVC	13/14
KENWOOD	15/16/17
KLH	18
LG	19
LUXMAN	59
MARANTZ	20/21
MCINTOSH	54
NAD	22/55
NAKAMICHI	60/61
ONKYO	23
OUTLAW	
PREAMP	56
PHILIPS	24/44
PIONEER	25/26/27/28
SAMSUNG	45/46/47
SONY	29/30/31
TEAC	32/33/34
THOMSON	43/53
YAMAHA	36/37/38/39/40/41/42

Network connection

The following services can be used when this unit is connected to broadband.

- Firmware can be updated (⇒ below)
- You can enjoy the BD-Live (⇒ 19)
- You can enjoy the VIERA CAST (⇒ 25)



NOTE

- Use shielded LAN cables when connecting to peripheral devices.
- When operating the VIERA CAST, use high-speed internet service no less than 1.5 Mbps for SD (Standard Definition) and 6 Mbps for HD (High Definition) picture quality by your local broadband company.
 - If using slow Internet connection, the video may not be displayed correctly.
- After connecting to the Internet, perform necessary settings. (⇒ 14)
- Inserting any cable other than a LAN cable in the LAN terminal can damage the unit.

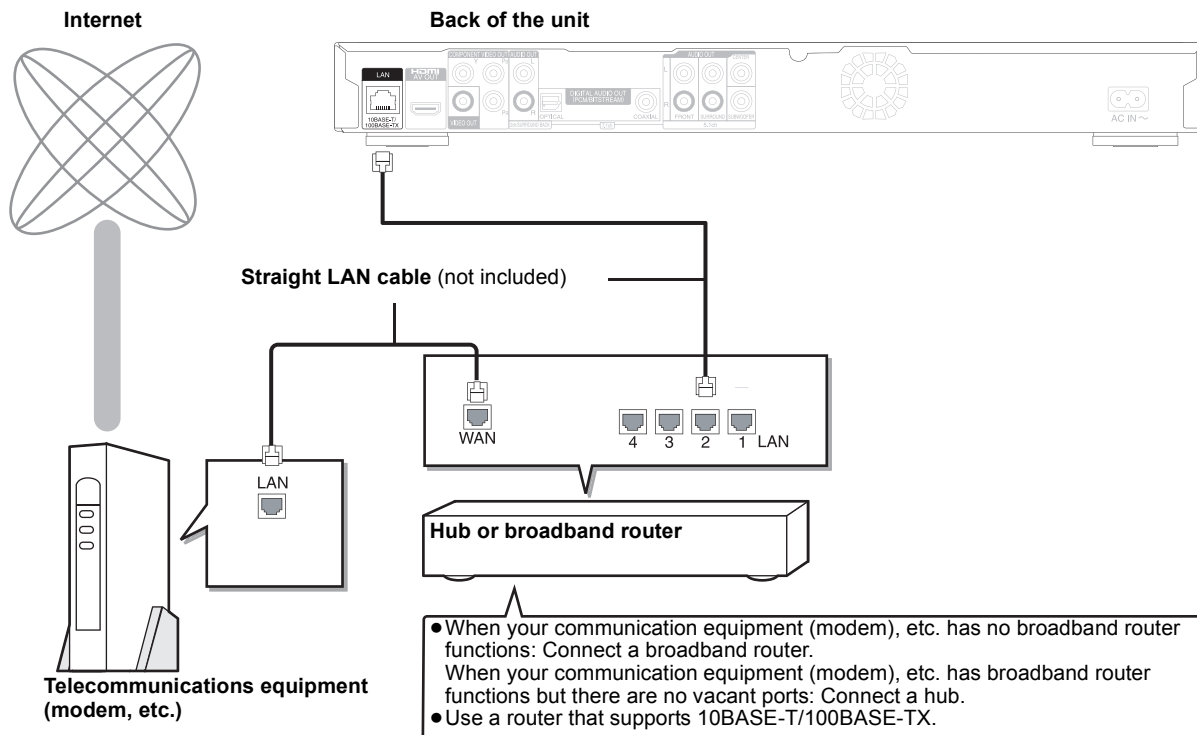

Firmware updating

When this unit remains connected to the Internet, it will automatically check for the latest firmware version when it is turned on.

When latest firmware version is available, the following screen is displayed. Select "Yes" or "No".

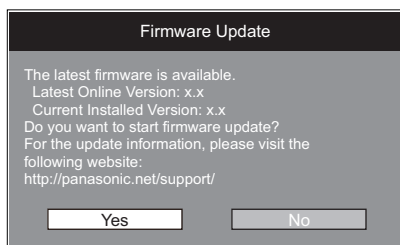

- If "Yes" is selected, then follow the on-screen instructions.
- If "No" is selected, then manually update the firmware later. (⇒ right)

After the latest firmware is downloaded, the system will be restarted and the firmware will be updated.

When the system is restarted, the screen display disappears and "START" is displayed on the unit's display.



After the firmware is updated and the system is restarted, the following screen indicates that the firmware update has been completed.

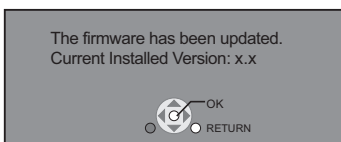

- During the update process, no other operations can be performed. Serious damage may occur if you turn off the unit and/or press any buttons.



NOTE

- Downloading will require several minutes. It may take longer or the Internet may not be connected depending on the connection environment. It is required that you use a broadband connection.



TIPS

- If downloading on this unit fails or this unit is not connected to the Internet, then you can download the latest firmware from the following website and burn it to a CD-R to update the firmware.
<http://panasonic.net/support/>
(This site is in English only.)
- When the unit is connected to the Internet, communication charges may be generated.
- If you do not want to check for the latest firmware version when the unit is turned on, set "Automatic Update Check" to "Off". (⇒ 32)

Manually updating the firmware

If the firmware update is not carried out when the unit is turned on, a message is displayed when displaying the FUNCTIONS menu.



- 1) Press [SETUP].
- 2) Press [▲, ▼] to select "General" and press [OK].
- 3) Press [▲, ▼] to select "Firmware Update" and press [OK].
- 4) Press [▲, ▼] to select "Update Now" and press [OK].
- 5) Press [◀, ▶] to select "Yes" and press [OK].

Network settings

These settings are used if you will connect this unit to the Internet.

- The connection to the Internet may take time or the Internet may not be connected depending on the connection environment. (⇒ 32)
It is required that you use a broadband connection.

Preparation

- Connect to the network. (⇒ 13)

Testing of “IP Address / DNS Settings”

Always test the connection when a LAN cable is connected.

- 1 Press [SETUP].
- 2 Press [▲, ▼] to select “Network Settings” and press [OK].
- 3 Press [▲, ▼] to select “IP Address / DNS Settings” and press [OK].
- 4 Press [▲, ▼] to select “Connection Test” and press [OK].

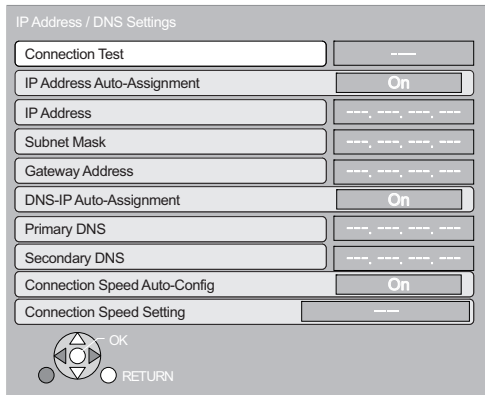

“Testing...”: The test is in progress.

“Pass”: The connection is completed.

Press [RETURN] to exit.

“Fail”: Please check the connection and settings.

Note

- Perform the “Connection Test” also when any change was made to the “IP Address / DNS Settings”.
- If the connection test fails, it may be necessary to set the MAC address of this unit at the router side. The MAC address can be displayed by pressing [SETUP] and selecting “Network Settings”.

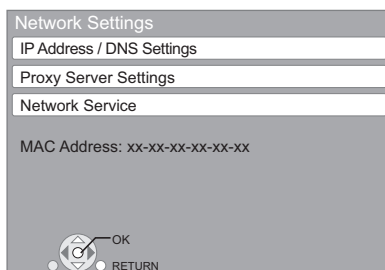

Setting the IP address

In most cases, default settings can normally be used without making any changes.

Set the IP address only when the router has no DHCP server functions or when the router’s DHCP server function is disabled.

After performing steps 1–3 (⇒ left)

- 4 Press [▲, ▼] to select “IP Address Auto-Assignment” and press [◀, ▶] to select “Off”.
- 5 Press [▲, ▼] to select “IP Address”, “Subnet Mask” or “Gateway Address” and press [OK].
- 6 Enter numbers with the numbered buttons and press [OK].
 - After checking the specifications for your broadband router, enter each number.
 - If the number is unknown, then check the number of other devices such as personal computers connected via a LAN cable. Assign a different number from those of other devices for the “IP Address” and the same number for others.
 - If a wrong number is entered, then press [CANCEL].
- 7 Press [◀, ▶] to select “Yes” and press [OK].

Note

- The numeric input range is between 0 and 255.

Setting the DNS-IP

In most cases, default settings can normally be used without making any changes.

When setting an assigned DNS server from your Internet service provider, perform the following settings.

After performing steps 1–3 (⇒ left)

- 4 Press [▲, ▼] to select “DNS-IP Auto-Assignment” and press [◀, ▶] to select “Off”.
- 5 Press [▲, ▼] to select “Primary DNS” or “Secondary DNS” and press [OK].
- 6 Enter numbers with the numbered buttons and press [OK].
 - Follow the instructions given by your Internet service provider and enter the numbers.
 - If the number is unknown, then check the number of other devices such as personal computers connected via a LAN cable and assign the same number.
 - If a wrong number is entered, then press [CANCEL].

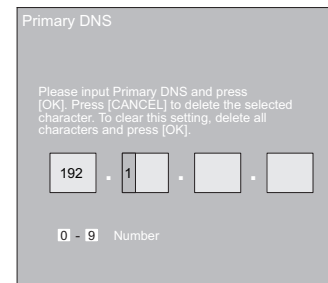

- 7 Press [◀, ▶] to select “Yes” and press [OK].

Note

- The numeric input range is between 0 and 255.

Setting the connection speed

When the connection test results in "Fail" after the IP and DNS-IP addresses are assigned, perform the following settings.

After performing steps ①-③ (⇒ 14)

- ④ Press [▲, ▼] to select "Connection Speed Auto-Config" and press [◀, ▶] to select "Off".
- ⑤ Press [▲, ▼] to select "Connection Speed Setting" and press [◀, ▶] to select a connection speed.
 - Select a connection speed in accordance with the environment of the network connected.
 - When the settings are changed, the network connection may be disabled depending on the device.

Testing of "Proxy Server Settings"

Always test the connection when new "Proxy Server Settings" have been made.

- ① Press [SETUP].
- ② Press [▲, ▼] to select "Network Settings" and press [OK].
- ③ Press [▲, ▼] to select "Proxy Server Settings" and press [OK].
- ④ Press [▲, ▼] to select "Connection Test" and press [OK].

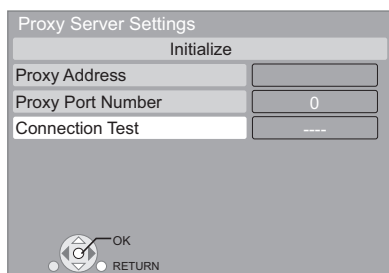

"Testing...": The test is in progress.

"Pass": The connection is completed.

Press [RETURN] to exit.

"Fail": Please check the connection and settings.

Setting the proxy server

In most cases, default settings can normally be used without making any changes.

Please use this setting when instructed to by your Internet service provider.

After performing steps ①-③ (⇒ left)

- ④ Press [▲, ▼] to select "Proxy Address" and press [OK].
 - The text entry screen is displayed.
 - Text field: shows the text you have entered

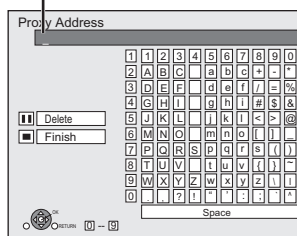

- ⑤ Press [▲, ▼, ▶, ◀] to select a character and press [OK].

Repeat this step to enter other characters.

- Press [II] to delete.

- ⑥ Press [■] when you complete the entry.
- ⑦ Press [▲, ▼] to select "Proxy Port Number" and press [OK].
- ⑧ Enter numbers with the numbered buttons and press [OK].

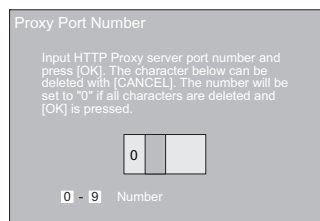

- ⑨ Press [◀, ▶] to select "Yes" and press [OK].



TIPS

- The specified ports may be blocked and not be able to be used depending on the network environment.

In order to restore the default settings

After performing steps ①-⑨ (⇒ left)

- 1) Press [▲, ▼] to select "Initialize" and press [OK].
- 2) Press [◀, ▶] to select "Yes" and press [OK].

Using the numbered buttons to enter characters
e.g., entering the letter "F"

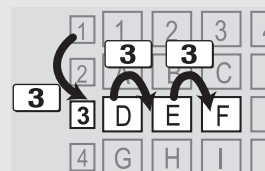

- 1) Press [3] to move to the 3rd row.
- 2) Press [3] twice to highlight "F".
- 3) Press [OK].

Basic operation

Inserting or removing a media

Inserting or removing a disc

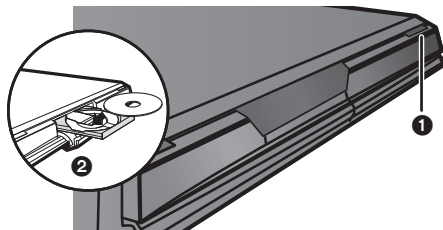

- 1 Press [▲ OPEN/CLOSE] to open the disc tray.
 - 2 Insert or remove the disc.
- Press [▲ OPEN/CLOSE] again to close the disc tray.
 - DVD-RAM: Remove discs from their cartridges before use.
 - Insert double-sided discs so the label for the side you want to play is facing up.

Inserting or removing an SD card

Inserting a card

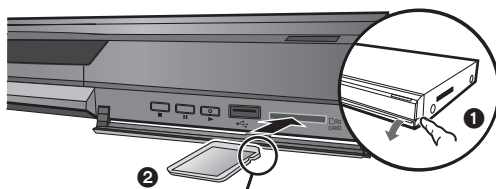

Insert the card label up with the cut-off corner on the right.

- 1 Pull to flip down the front panel.
- 2 Insert the SD card into the SD card slot.
 - Press on the center of the card until it clicks into place.

Removing the card

Press on the center of the card and pull it straight out.

- When the card indicator ("SD") on the unit's display is flashing, the card is being read from or written to. Do not turn off the unit or remove the card. Such action may result in malfunction or loss of the card's contents.

Inserting or removing a USB device

Inserting a USB device

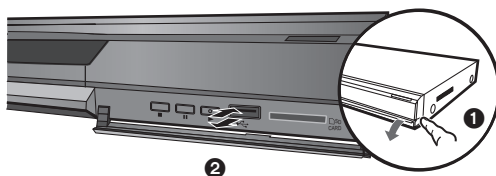

- Before inserting any USB device to this unit, ensure that the data stored therein has been backed up.
- Check the orientation of the USB connector and insert it straight in.
- Some USB devices inserted into this unit may cause this unit to stop operating. Such USB devices cannot be used on this unit.

- 1 Pull to flip down the front panel.
- 2 Insert the USB device into the USB port.

Removing the USB device

Complete all USB device-related operations and pull the USB device straight out.

- When the USB device indicator is flashing, the USB device is being read from. Do not turn off the unit or remove the USB device. Such action may result in malfunction or loss of the USB device's contents.

About the use of USB device

Since the physical size of USB device can vary, please consider its width when connecting any USB device to this unit. It is possible that some devices may accidentally activate the playback button and cause this unit to not operate properly.

- In such cases we recommend using a USB extension cable (not included).

Playing video contents

Instructions for operations are generally described using the remote control in these operating instructions.

Preparation

Turn on the television and select the appropriate video input on the television.

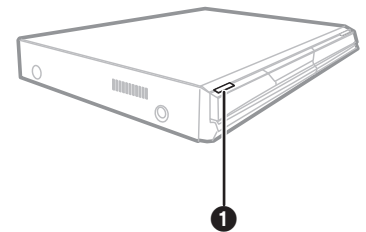
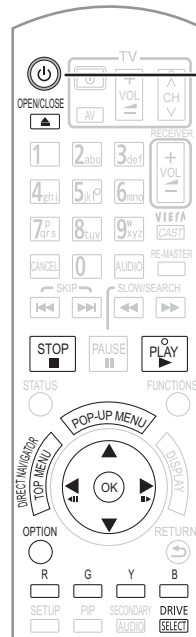
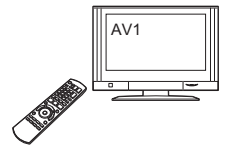

- 1 Press [⏻] to turn on the unit.
- 2 Insert the media (⇒ left).

Play starts.

- If play does not start, press [▶] (PLAY).
- If the media with data in different file formats is inserted, the file selection menu is displayed. Press [▲, ▼] to select the desired file format and press [OK].
- If the menu is displayed, press [▲, ▼, ◀, ▶] to select the item and press [OK].
- If the screen prompting you to use the color buttons appears, continue to operate with the color buttons on the remote control.

e.g.,



NOTE

- Signal from PAL discs is output as PAL. Signal from NTSC discs is output as "NTSC" or "PAL60". You can select "NTSC" or "PAL60" in "NTSC Contents Output" for NTSC discs. (⇒ 29)
- DISCS CONTINUE TO ROTATE WHILE MENUS ARE DISPLAYED. Press [■] when you have finished playback to protect the unit's motor, your television screen and so on.



TIPS

To switch drives

Press [DRIVE SELECT] to select "BD/DVD/CD", "SD card" or "USB device".

- If a media is inserted while the unit is stopped, the drive switches automatically depending on the inserted media.

To display menus

BD-V AVCHD DVD-VR DVD-V DivX
Press [TOP MENU/DIRECT NAVIGATOR].

To show Pop-up menu **BD-V**

The Pop-up menu is a special feature available with some BD-Video discs. This menu may vary with discs. For the operating method, refer to the instructions for the disc.

- 1) Press [POP-UP MENU].
 - 2) Press [▲, ▼, ◀, ▶] to select the item and press [OK].
- Pop-up menu also appears by pressing [OPTION] and selecting "Pop-up Menu".
 - Press [POP-UP MENU] to exit the screen.

- The producers of the disc can control how discs are played. So you may not always be able to control play as described in these operating instructions. Read the disc's instructions carefully.
- When playing a set of two or more BD-Video discs, the menu screen may continue to display even if the disc has been ejected.
- It may take time to read BD-Video discs that include BD-J (⇒ 42).



Stop

The stopped position is memorized.

Resume play function

Press [▶] (PLAY) to restart from this position.

- The position is cleared if the tray is opened or you press [■] several times to display "STOP" on unit's display.
- **BD-V**: On BD-Video discs including BD-J (⇒ 42), the resume play function does not work.
- **CD** **MP3** **DivX** **MPEG2**: The position is cleared if the unit is turned off.



Pause

Press [⏸] again or [▶] (PLAY) to restart play.

SLOW/SEARCH



Search/Slow-motion

The speed increases up to 5 steps.

- Press [▶] (PLAY) to revert to normal playback speed.
- For some discs, the speed may not change.

Search

While playing, press [◀◀] or [▶▶].

- **BD-V** **AVCHD** **DVD-VR** **DVD-V**: Audio is heard during first level of forward search.
- **DivX** **MPEG2**: Audio is not heard during all levels of search.
- **CD** **MP3**: The speed is fixed to a single step.

Slow-motion

While paused, press [◀◀] or [▶▶].

- **BD-V** **AVCHD**: Forward direction [▶▶] only.
- **DVD-VR**: If continued for approx. 5 minutes, slow-motion play pauses automatically.

SKIP



Skip

Skip to the title, chapter or track you want to play.

- Each press increases the number of skips.
- **DivX**: Backward direction [◀◀] only.



Starting from a selected item

Play starts from the selected title or chapter.

- BD-V** **AVCHD** **DVD-V**
 e.g., 5: [0] ⇒ [0] ⇒ [5] e.g., 5: [0] ⇒ [5]
 15: [0] ⇒ [1] ⇒ [5] 15: [1] ⇒ [5]

- While stopped (the image on the right is displayed on the screen), the title is designated. While playing, the chapter is designated.



Frame-by-frame

While paused, press [◀] (◀◀) or [▶] (▶▶).

Each press shows the next frame.

- Press and hold to change in succession forward or backward.
- Press [▶] (PLAY) to revert to normal playback speed.
- **BD-V** **AVCHD**: Forward direction [▶] (▶▶) only.

Screen Aspect

When black bars are shown at the top, bottom, left, and right sides of the screen, you can enlarge the image to fill the screen.

- ① Press [OPTION].
- ② Press [▲, ▼] to select "Screen Aspect" and press [OK].
- ③ Press [◀, ▶] to select "Side cut" or "Zoom".

Normal: Normal output

Side cut: The black bars on the right and left sides of the 16:9 image disappear and the image is enlarged. Please note that the right and left sides of the image are cut off when the black bar is not displayed.

Zoom: The black bars on the top and bottom sides of the 4:3 image disappear and the image is enlarged. Please note that the top and bottom sides of the image are cut off when the black bar is not displayed.

- **BD-V** **DVD-V**: "Side cut" does not have any effect.
- When "TV Aspect" (⇒ 31) is set to "4:3 Pan & Scan" or "4:3 Letterbox", the "Zoom" effect is disabled.

STATUS



Status messages

The status messages give you information about what is currently being played. Each time you press [STATUS], the information displayed will change.

e.g. **BD-V** Type of disc Play status

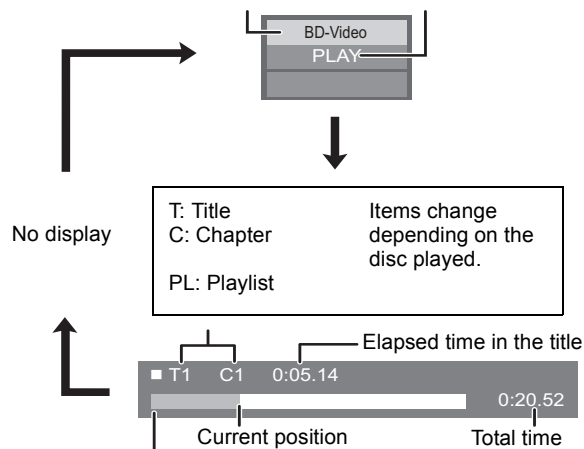

Other operations during play (Continued) (These functions may not work depending on the media.)

AUDIO

Changing audio during play

BD-V AVCHD DVD-V

e.g. DVD-V



English is selected.

You can change the audio channel number each time you press the button. This allows you to change the soundtrack language (⇒ 26, Soundtrack), etc.

DVD-VR DivX

AudioLR → AudioL → Audio R

"AudioLR" is selected

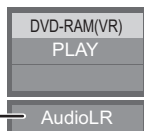

RE-MASTER



Reproducing more natural audio (Discs recorded at 48 kHz or less)

This feature gives you a more natural sound by adding higher frequency signals not recorded on the track.

Press [RE-MASTER] to select "Re-master 1", "Re-master 2" or "Re-master 3". Select the one that you like best.

Setting	When playing LPCM sound Type of music	Other types of sound Effect level
Re-master 1	High tempo (e.g., pop and rock)	Light
Re-master 2	Various tempos (e.g., jazz)	Medium
Re-master 3	Low tempo (e.g., classical)	Strong
Off	Off	Off

• This function is effective for audio from the HDMI terminal or the DIGITAL AUDIO OUT terminal only when "Dolby D/Dolby D +/ Dolby TrueHD" or "DTS/DTS-HD" is set to "PCM". (However, in this case, audio is output as 2ch from the DIGITAL AUDIO OUT terminal.)

Chapter playback

DVD-VR

- 1 Insert a disc (⇒ 16).
- 2 While "Title View" screen is displayed Press [▲, ▼] to select the title and press [OPTION].

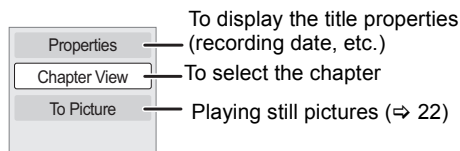

- 3 Press [▲, ▼] to select "Chapter View" and press [OK].
- 4 Press [◀, ▶] to select the chapter and press [OK].

Playing HD Video or SD Video

AVCHD MPEG2

It is possible to playback the HD (High Definition) video recorded on the Panasonic High definition Video Camera on the DVD-RAM/R/RW/R DL +R/+RW/+R DL or SD card, and SD (Standard Definition) Video recorded on the Panasonic SD Video Camera on the SD card.

- 1 Insert a disc or SD card. (⇒ 16)
 - "Title View" or "Video (MPEG-2)" screen is displayed.

e.g.,



- If a media containing data in different file formats is inserted, the file selection menu may be displayed. Press [▲, ▼] to select "Play Video (AVCHD)" or "Play Video (MPEG-2)" and press [OK].

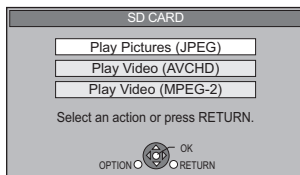

- 2 Press [▲, ▼, ▶, ◀] to select the title and press [OK].

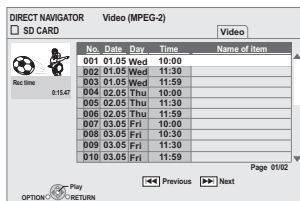

To return to the previous screen Press [RETURN].

To exit the screen Press [DIRECT NAVIGATOR].

To switch from other menus to AVCHD or MPEG2 menu (If the media contains data in different file formats)

- 1) Press [FUNCTIONS].
- 2) Press [▲, ▼] to select "Menu" and press [OK].
- 3) Press [▲, ▼] to select "Play Video (AVCHD)" or "Play Video (MPEG-2)" and press [OK].



NOTE

- It may pause for a few seconds on the break of images when editing such as partial deletion is performed.
- High definition video (transfer rate of 18 Mbps or faster) cannot be played back correctly if it was recorded on a DVD compatible to double speed or slower.

Enjoying BD-LIVE or BONUSVIEW in BD-Video

BD-V

What is BONUSVIEW?

BONUSVIEW allows you to enjoy functions such as picture-in-picture or secondary audio etc., with BD-Video supporting BD-ROM Profile 1 version 1.1/ Final Standard Profile.

What is BD-Live?

In addition to the BONUSVIEW function, BD-Video supporting BD-ROM Profile 2 that has a network extension function allows you to enjoy more functions such as subtitles, exclusive images and online games by connecting this unit to the Internet. In order to use the Internet feature, you must have this unit connected to a broadband network (⇒ 13).

- These discs may not be on sale in certain regions.
- The usable functions and the operating method may vary with each disc, please refer to the instructions on the disc and/or visit their website.

Playing secondary video (picture-in-picture) and secondary audio

To turn on/off secondary video

Press [PIP].

Secondary video is played.

- “PiP ON” is displayed.
- Press the button to turn it ON and OFF.

To turn on/off secondary audio

Press [SECONDARY AUDIO].

The secondary audio is played.

- “Secondary Audio ON” is displayed.
- Press the button to turn it ON and OFF.

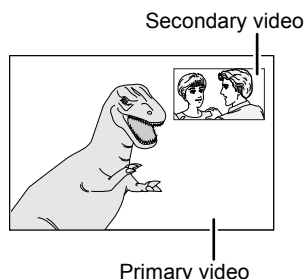

NOTE

- Discs may not always be played back according to the settings on this unit, as certain playback formats are prioritized on certain discs.
- Only the primary video is played during search/slow-motion or frame-by-frame.
- When “BD-Video Secondary Audio” in “Digital Audio Output” is set to “Off”, secondary audio will not be played even if [SECONDARY AUDIO] is pressed. Please check that “BD-Video Secondary Audio” is set to “On” (⇒ 30).
- When the secondary video is turned off, the secondary audio is not played.

Enjoying BD-Live discs with Internet

Many BD-Live compatible discs require content to be downloaded onto an SD card (⇒ 43, Local storage) in order to access the available BD-Live features.

- An SD card with 1 GB or more of free space (SD Speed Class Rating 2 or higher) needs to be inserted prior to inserting the BD-Live compatible disc.

Some BD-Live content available on the Blu-ray discs may require an Internet account to be created in order to access the BD-Live content. Follow the screen display or instruction manual of the disc for information on acquiring an account.

Preparation

- Connect to the network. (⇒ 13)

❶ Insert an SD card (⇒ 16).

- If the SD card menu screen is displayed, press [DRIVE SELECT] on the remote control, select “BD/DVD/CD”.

❷ Insert the disc (⇒ 16).

- For operation method, refer to the instructions on the disc.

To use the above functions, it is recommended that you format the card on this unit. Format the card using the following procedures.

Formatting SD cards/Deleting data

It is impossible to restore data after formatting the card or erasing the data.

Once a card is formatted, all data including those recorded on the PC is erased as well, even if the data were protected with other equipment.

- 1) Insert an SD card (⇒ 16).
- 2) Press [FUNCTIONS].
- 3) Press [▲, ▼] to select “To Others” and press [OK].
- 4) Press [▲, ▼] to select “Card Management” and press [OK].
- 5) Press [▲, ▼] to select “BD-Video Data Erase” or “Format SD Card” and press [OK].
- 6) Press [◀, ▶] to select “Yes” and press [OK].
- 7) Press [◀, ▶] to select “Start” and press [OK].

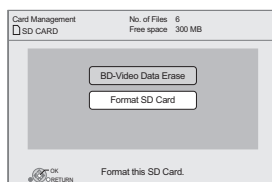

NOTE

- While using this feature, do not remove the SD card. Doing so will cause playback to stop.
- A message may be displayed when SD card doesn't have enough storage capacity for BD-Live content. Please make space available on the current SD card, or insert another SD card.
- The unit must be connected to the Internet and set up (⇒ 14) to use the BD-Live functions. “BD-Live Internet Access” may need to be changed for certain discs (⇒ 29).
- When discs supporting BD-Live are played back, the player or disc IDs may be sent to the content provider via the Internet. You can restrict Internet access (“BD-Live Internet Access” ⇒ 29).
- The unit is connected to the Internet when BD-Live functions are used, generating communication charges.
- The playback may be paused depending on the communication environment. Some functions may be disabled to prevent skipping to sections that have not been downloaded, etc.

Enjoying High Bit rate Audio and Video

This unit supports high bit rate audio (Dolby Digital Plus, Dolby TrueHD, DTS-HD High Resolution Audio and DTS-HD Master Audio) adopted in BD-Video.

Enjoying High Bit rate Audio with 7.1ch speaker and 5.1ch speaker

To enjoy above high bit rate audio, the following conditions are necessary. (Part shown in the shaded area of table given below)

NECESSARY CONNECTIONS

- HDMI AV OUT terminal: (⇒ 9)
- 7.1ch AUDIO OUT terminal **[BD80]**: (⇒ 9)/ 5.1ch AUDIO OUT terminal **[BD80]**: (⇒ 10)

NECESSARY SETTINGS

- Set "BD-Video Secondary Audio" to "Off". (⇒ 30)
- HDMI AV OUT terminal: Set "Dolby D/Dolby D +/Dolby TrueHD" or "DTS/DTS-HD" to "Bitstream" or "PCM". (⇒ 30)
- 7.1ch AUDIO OUT terminal **[BD80]**: Set "Analog Audio Output" to "7.1ch". (⇒ 31)
- 5.1ch AUDIO OUT terminal **[BD80]**: Set "Analog Audio Output" to "2ch (Downmix) + 5.1ch". (⇒ 31)

About audio from audio output terminal

Connect an amplifier/receiver (⇒ 9, 10) and confirm the desired audio type and necessary settings ("BD-Video Secondary Audio", "Dolby D/Dolby D +/Dolby TrueHD" or "DTS/DTS-HD").

- The number of channels listed is the maximum possible number of output channels.
- Also, depending on the specifications or the settings of the amplifier/receiver, the results of the output may vary.

Terminal	HDMI AV OUT		DIGITAL AUDIO OUT		7.1ch AUDIO OUT [BD80]		5.1ch AUDIO OUT [BD80]		
	"Bitstream"*1		"PCM"*3		"Bitstream"	"PCM"	—		
"BD-Video Secondary Audio"	"On"*2	"Off"	"On"	"Off"	"On"/"Off"	"On"/"Off"	"On"	"Off"	"On"/"Off"
Dolby Digital/ Dolby Digital EX*5	Dolby Digital/ Dolby Digital EX*6	Dolby Digital/ Dolby Digital EX	5.1ch PCM		Dolby Digital/ Dolby Digital EX*6	Down-mixed 2ch PCM	5.1ch		5.1ch
Dolby Digital Plus	Dolby Digital	Dolby Digital Plus	5.1ch PCM*2	7.1ch PCM	Dolby Digital		5.1ch*2	7.1ch	
Dolby TrueHD		Dolby TrueHD							
DTS Digital Surround/ DTS-ES*5	DTS Digital Surround/ DTS-ES*6	DTS Digital Surround/ DTS-ES	DVD-V : 5.1ch PCM		DTS Digital Surround/ DTS-ES*6		DVD-V : 5.1ch		
			BD-V : 7.1ch PCM*4				BD-V : 7.1ch*4		
DTS-HD High Resolution Audio	DTS Digital Surround	DTS-HD High Resolution Audio	7.1ch PCM*4		DTS Digital Surround		7.1ch*4		
DTS-HD Master Audio		DTS-HD Master Audio							
7.1ch LPCM	Down-mixed 5.1ch PCM	7.1ch PCM	Down-mixed 5.1ch PCM*2	7.1ch PCM	Down-mixed 2ch PCM	Down-mixed 5.1ch*2	7.1ch		

*1 When the connected equipment is not supported with these audio format, the audio is output as Dolby Digital bitstream, DTS Digital Surround bitstream or down-mixed 2ch PCM (e.g., TV).

*2 **BD-V**: When playing BD-Video without secondary audio or clicking sound, the audio is output as the same format as if "BD-Video Secondary Audio" was set to "Off".

*3 When the connected equipment is not supported with multi channel surround, the audio is output as down-mixed 2ch PCM.

*4 **BD-V**: When the connected equipment is supported with 7.1 channel surround, the audio output is amplified from 5.1ch or 6.1ch to 7.1ch depending on the DTS, Inc. specifications.

*5 With PCM output, Dolby Digital EX becomes PCM audio decoded as Dolby Digital, DTS-ES recorded to DVD-Video becomes PCM audio decoded as DTS Digital Surround, and DTS-ES recorded to BD-Video becomes PCM audio decoded as DTS-ES.

*6 **BD-V**: When "BD-Video Secondary Audio" is set to "On", Dolby Digital EX is output as Dolby Digital and DTS-ES is output as DTS Digital Surround, however if playing BD-Video without secondary audio or clicking sound, the audio is output as the original format.

NECESSARY SETTINGS

- HDMI AV OUT/DIGITAL AUDIO OUT terminal: "Digital Audio Output" (⇒ 30)
- **[BD80]** 7.1ch AUDIO OUT/5.1ch AUDIO OUT terminal: "Digital Audio Output" and "Analog Audio Output" (⇒ 30, 31)

Note

- When setting "BD-Video Secondary Audio" to "Off", the clicking sound on the menu and audio with secondary video in picture-in-picture mode (⇒ 19) cannot be output.

Regarding 24p output

Many BD-Video movie contents are recorded in 24 frames/second in accordance with the film materials. However, they will normally be output in 60 frames/second in accordance with the display format.

These can be output in 24p as the original. Therefore, high-quality video can be enjoyed, such as the improved clarity, enhanced perspective, etc.

NECESSARY CONNECTIONS

- Connect to a TV supporting 1080/24p input via an HDMI cable.

NECESSARY SETTINGS

- "24p Output": "On" (⇒ 31)

Playing music

CD MP3

You can play generally available music CD or MP3 files recorded onto a DVD-R/R DL, CD-R/RW and USB device.
(About structure of folders ⇒ 35, "Structure of folders that can play back on this unit")

1 Insert a disc or USB device. (⇒ 16) e.g.

- If the media containing data in different file formats is inserted, the file selection menu may be displayed. Press [▲, ▼] to select "Play Music (MP3)" and press [OK].

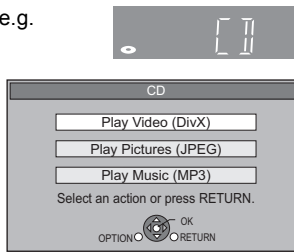

2 Press [▲, ▼] to select the track and press [OK].

Play starts on the selected track.

- CD "TR" and the track number being played back are displayed on the unit's display.

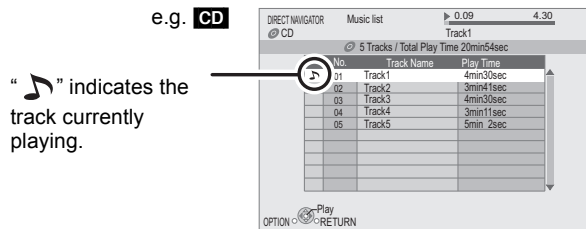

MP3 Playing a track in another folder

- While the "Music list" is displayed Press [OPTION], press [▲, ▼] to select "Select Folder" and press [OK].

Selected folder No. /Total folders
If the folder has no track, "--" is displayed as folder number.

- Press [▲, ▼] to select a folder and press [OK].
The "Music list" for the folder appears.

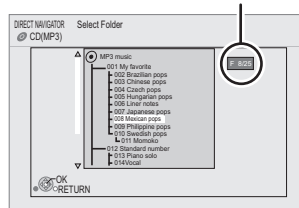

Playing music continuously even after turning off power to the television

When the unit is connected to a Panasonic TV (VIERA) that supports HDAVI Control 2 or later and other device supports VIERA Link, the unit is turned off if the power to the television is turned off, since "Power off link" (⇒ 28) operates.

The following operations make it possible to keep the power of the unit ON and to play music continuously.

- While playing music Press [OPTION].
- Press [▲, ▼] to select "TV Power" and press [OK].



TIPS

To switch from other menus to MP3 menu
(If the media contains data in different file formats)

- 1) Press [FUNCTIONS].
- 2) Press [▲, ▼] to select "Menu" and press [OK].
- 3) Press [▲, ▼] to select "Play Music (MP3)" and press [OK].

- You can use search and skip functions. (⇒ 17)
- When the "Screen Saver Function" is set to "On" (⇒ 30), the screen switches to Screen Saver mode if there is no operation for 10 minutes after starting playback. (Playback continues.)



NOTE

- You cannot select folders that contain no compatible tracks.



TIPS

To return to the previous screen
Press [RETURN].



NOTE

- Sound may be discontinued for several seconds when the power to the television is turned off.
- If the operation mentioned left is executed while audio is output from the television, the sound may not be output from the device. It is recommended to set the device beforehand so that audio will be output from the device.

Playing still pictures

JPEG

Playback of the BD-RE, DVD-RAM/R/R DL or CD-R/RW with still pictures recorded. This unit can also play still pictures recorded on the SD card or USB memory. In addition, you can also connect Panasonic digital camera by USB connection.

(About structure of folders ⇒ 35, "Structure of folders that can play back on this unit")

1 Insert a disc, SD card or USB device. (⇒ 16)

BD-RE, DVD-RAM

"Album View" screen is displayed

- When the "Title View" screen is displayed, press the [G] button to switch to the "Album View" screen.
- If the DVD-RAM containing both JPEG and AVCHD format is inserted, the file selection menu may be displayed.

DVD-R/R DL, CD-R/RW, SD card, USB device

- If the media containing data in different file formats is inserted, the file selection menu may be displayed.

e.g.,



Press [▲, ▼] to select "Play Pictures (JPEG)" and press [OK].

e.g.,

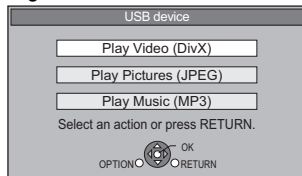

"Picture View" screen is displayed

⇒ Go to step 2

2 Press [▲, ▼, ◀, ▶] to select the album and press [OK].

e.g.,

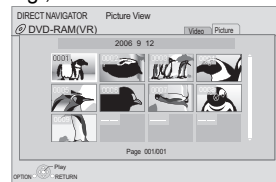

3 Press [▲, ▼, ◀, ▶] to select the still picture and press [OK].

Connecting a USB device



USB connection cable
Specified cable such as accessory of the USB equipment

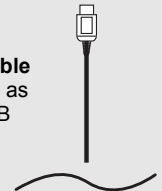

Connect to USB terminal

Panasonic digital camera, etc.



NOTE

- Setup screen may be displayed on equipment connected with the USB. Set it to the mode for connecting to a PC.
- Also read the operating instructions of the connected equipment for details of connection and setup.
- Do not disconnect the USB connection cable while recognizing.



TIPS

- Press [◀, ▶] to display the previous or next still picture.
- Press [◀◀, ▶▶] to show other pages.

To return to the previous screen

Press [RETURN].

To exit the screen

Press [DIRECT NAVIGATOR].

DVD-RAM/R/R DL, CD-R/RW, SD card, USB device

To switch from other menus to JPEG menu

(If the media contains data in different file formats)

- 1) Press [FUNCTIONS].
- 2) Press [▲, ▼] to select "Menu" and press [OK].
- 3) Press [▲, ▼] to select "Play Pictures (JPEG)" and press [OK].



NOTE

- Small-sized still pictures are displayed with a frame.

Start Slideshow

You can display still pictures one by one at a constant interval.

BD-RE, DVD-RAM

- ① While the "Album View" screen is displayed
Press [▲, ▼, ◀, ▶] to select the album and press [OPTION].
 - ② Press [▲, ▼] to select "Start Slide Show" and press [OK].
- You can also start slideshow by pressing [▶] (PLAY) after selecting the album.

DVD-R/R DL, CD-R/RW, SD card, USB device

- ① While the "Picture View" screen is displayed
Press [OPTION].
- ② Press [▲, ▼] to select "Start Slide Show" and press [OK].

To stop slideshow

Press [■].

Slideshow settings

In step ② in Start Slideshow above,

- ① Press [▲, ▼] to select "Slide Show Setting" and press [OK].

② To change the display interval

Press [▲, ▼] to select "Display interval" and press [◀, ▶] to select the interval ("Long", "Normal" or "Short").

- When a still picture with large number of pixels is played, the display interval may become longer. Even if the setting is changed, the display interval may not become shorter.

To set display method

Press [▲, ▼] to select "Transition Effect" and press [◀, ▶] to select "Fade", "Motion" or "Random".

"Fade": Pictures are changed by fading out and fading in.

"Motion": Pictures are changed by fading out and fading in, while it is enlarged, reduced, or moved up or down.

"Random": In addition to the "Motion", pictures are changed by various methods.

To repeat slideshow

Press [▲, ▼] to select "Repeat Play" and press [◀, ▶] to select "On" or "Off".

To listen to a BGM

The MP3 that is recorded on the USB device or the music CD can be played back as BGM during the slideshow.

Press [▲, ▼] to select "Soundtrack" and press [◀, ▶] to select "On" or "Off".

- You cannot search or skip on the music.
- When the slideshow stops, the playback of the music also stops.
- When both the music CD and the USB device with MP3 recorded is inserted to this unit, the music CD has a priority to be played back as BGM.

To select a folder

A folder to playback can be selected when a USB device with MP3 recorded is connected to this unit.

Press [▲, ▼] to select "Soundtrack Folder" and press [OK], and press [◀, ▶] to select folder.

- ③ Press [▲, ▼, ◀, ▶] to select "Set" and press [OK].

Rotate

- ① While playing (except for slideshows)
Press [OPTION].
 - ② Press [▲, ▼] to select "Rotate RIGHT" or "Rotate LEFT" and press [OK].
- The rotation information will be stored until the unit is turned off or the media is removed.

Zoom out

This function is only available for small-sized still pictures.

- ① While playing (except for slideshows)
Press [OPTION].
 - ② Press [▲, ▼] to select "Zoom out" and press [OK].
- To cancel "Zoom out", press [▲, ▼] to select "Zoom in" in step ② and press [OK].
 - The zoom-out information will not be stored.

To select the still pictures in another folder

BD-RE, DVD-RAM

To switch to another higher folder

(Only if there is a multiple number of higher folders recognizable)

- ① While the "Album View" screen is displayed
Press [OPTION].
- ② Press [▲, ▼] to select "Select Folder" and press [OK].

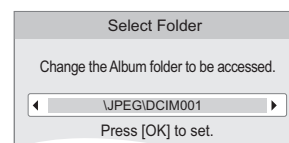

- ③ Press [◀, ▶] to select the higher folder and press [OK].

DVD-R/R DL, CD-R/RW

- ① While the "Picture View" screen is displayed
Press [OPTION].
- ② Press [▲, ▼] to select "Folder" and press [OK].
- ③ Press [▲, ▼] to select a folder and press [OK].
The "Picture View" screen for the folder appears.

e.g.

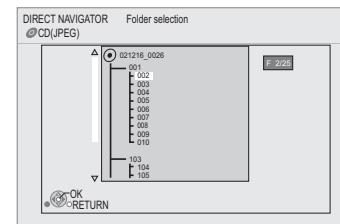

To show the picture properties

While playing
Press [STATUS] twice.

e.g. JPEG on DVD-RAM

Shooting date



To exit, press [STATUS].

Playing DivX® videos

DivX

ABOUT DIVX VIDEO:

DivX® is a digital video format created by DivX, Inc. This is an official DivX Certified device that plays DivX video. You can play DVD-R/R DL, CD-R/RW discs and USB device which contain DivX video contents that have been recorded on a personal computer. (About structure of folders ⇒ 35, "Structure of folders that can play back on this unit")

● Because DivX format can use many different codecs, there is no guarantee that all DivX files will play. (⇒ 34, "About MP3/JPEG/DivX files")

1 Insert a disc or a USB device. (⇒ 16)

● If the disc containing data in different file formats is inserted, the file selection menu may be displayed. Press [▲, ▼] to select "Play Video (DivX)" and press [OK].

e.g.,

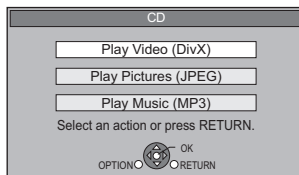

2 Press [▲, ▼] to select the title and press [OK].

Play starts on the selected title.

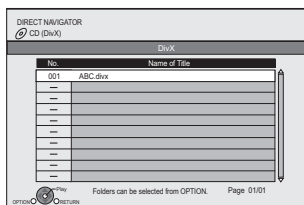

Playing a title in another folder

1 While the "DIRECT NAVIGATOR" is displayed Press [OPTION], press [▲, ▼] to select "Folder" and press [OK].

e.g.,

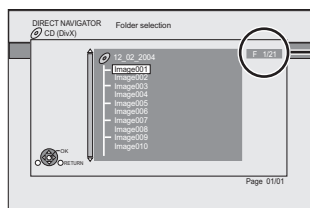

Selected folder No. /Total folders
If the folder has no title, "--" is displayed as folder number.

2 Press [▲, ▼] to select a folder and press [OK].
The "DIRECT NAVIGATOR" for the folder appears.



NOTE

- The picture sizes set for recording may prevent the unit from showing pictures in the proper aspect. You may be able to adjust the aspect through the TV.
- Successive play is not possible.



TIPS

- You can use search and skip functions. (⇒ 17)
- Press [◀◀, ▶▶] to show other pages.

DVD-R/R DL, CD-R/RW, USB device To switch from other menus to DivX menu

(If the media contains data in different file formats)

- 1) Press [FUNCTIONS].
- 2) Press [▲, ▼] to select "Menu" and press [OK].
- 3) Press [▲, ▼] to select "Play Video (DivX)" and press [OK].



NOTE

- You cannot select folders that contain no compatible files.



TIPS

To return to the previous screen
Press [RETURN].

Regarding DivX VOD content

ABOUT DIVX VIDEO-ON-DEMAND:

This DivX® Certified device must be registered in order to play DivX Video-on-Demand (VOD) content.

First generate the DivX VOD registration code for your device and submit it during the registration process. [Important: DivX VOD content is protected by a DivX DRM (Digital Rights Management) system that restricts playback to registered DivX Certified devices. If you try to play DivX VOD content not authorized for your device, the message "Authorisation Error." will be displayed and your content will not play.]

Learn more at www.divx.com/vod.

Display the unit's registration code.

(⇒ 32, "DivX Registration" in "General")



8 alphanumeric characters

- After playing DivX VOD content for the first time, another registration code is then displayed in "DivX Registration". Do not use this registration code to purchase DivX VOD content. If you use this code to purchase DivX VOD content, and then play the content on this unit, you will no longer be able to play any content that you purchased using the previous code.
- If you purchase DivX VOD content using a registration code different from this unit's code, you will not be able to play this content. ("Authorisation Error." is displayed.)

Regarding DivX VOD content that can only be played a set number of times

Some DivX VOD content can only be played a set number of times. When you play this content, the remaining number of plays is displayed. You cannot play this content when the number of remaining plays is zero. ("Rental Expired." is displayed.)

When playing this content

- The number of remaining plays is reduced by one if
 - you press [⏻].
 - you press [■].
 - you press [DIRECT NAVIGATOR].
 - you press [◀◀] or [◀, ▶▶] etc. and arrive at another content or the start of the content being played.
 - you press [DRIVE SELECT] to change the drive.
- Resume functions do not work.

Displaying subtitles text

You can display subtitles text onto the DivX video disc on this unit. This function has no relation to the subtitles specified in DivX standard specifications and has no clear standard. The operation might be different or it may not operate properly depending on the way the file was made or the state of this unit (playing, stopped, etc.).

- 1 While playing, press [DISPLAY].
- 2 Press [▲, ▼] to select "Disc" and press [▶].
- 3 Press [▲, ▼] to select "Subtitle" and press [▶].
- 4 Press [▲, ▼] to select "On" and press [▶].

5 Press [▲, ▼] to select "Text".

- DivX video files that do not display "Text" do not contain subtitles text.
Subtitles text cannot be displayed.

- If the subtitles text are not displayed correctly, try changing the language settings. (⇒ 29)

To exit the screen

Press [DISPLAY].

Enjoying VIERA CAST™

You can access a selection of Internet services from the Home screen with VIERA CAST, for example YouTube, Picasa Web Albums. (Current as of January 2009)

- VIERA CAST requires a broadband Internet connection. Dial-up Internet connections cannot be used.

Preparation

- Network connection (⇒ 13)
- Network setting (⇒ 14)

1 Press [VIERA CAST].

- Message is displayed. Please read these instructions carefully and then press [OK] to start VIERA CAST function.

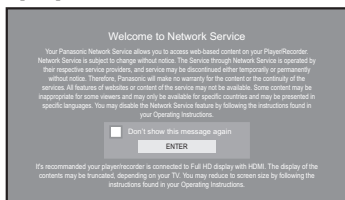

Images are for illustration purpose, message may change without notice.

2 Press [▲, ▼, ◀, ▶] to select the item and press [OK].

- You can operate VIERA CAST using the following buttons on the unit's remote control. [▲, ▼, ◀, ▶], [OK], [RETURN], [OPTION], colored buttons and numbered buttons.
- To access more features on YouTube or Picasa Web Albums site, enter your user ID and password that you have previously set up with these sites through the internet on your PC. However, not all features may be accessible through VIERA CAST.

VIERA CAST Home screen;

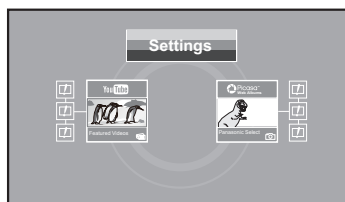

Images are for illustration purpose, contents may change without notice.

Regarding "Settings"

Set VIERA CAST Home screen.

- **My Account:** You can remove your account from the unit.
- **Lock:** Enter a password to lock YouTube and Picasa Web Albums.
- **Notices**



- Depending on the usage conditions, it may take a while to read all the data.
- The connection to the Internet may take time or the Internet may not be connected depending on the connection environment.
- The unit is connected to the Internet when VIERA CAST is used, generating communication charges.



To return to VIERA CAST Home screen
Press [VIERA CAST].

To exit from VIERA CAST

Press [FUNCTIONS] or [TOP MENU/DIRECT NAVIGATOR], then press [RETURN] to cancel the menu.

- Set the "Network Lock" to "On" to restrict using VIERA CAST. (⇒ 32)
- Set the "Audio Auto Gain Control" to "Off" when the audio is warped while using the VIERA CAST. (⇒ 32)
- When display of the contents is truncated, set the "Reduced Screen Display" to "On". (⇒ 32)
- Set the "On-Screen Language", to switch the language for Home screen. (⇒ 30)
- Set the "Time Zone" or "Summer Time" when wrong time is displayed on the screen. (⇒ 32)



- VIERA CAST™ home screen is subject to change without notice.
- The services through VIERA CAST™ are operated by their respective service providers, and service may be discontinued either temporarily or permanently without notice. Therefore, Panasonic will make no warranty for the content or the continuity of the services.
- All features of websites or content of the service may not be available.
- Some content may be inappropriate for some viewers.
- Some content may only be available for specific countries and may be presented in specific languages.

Showing FUNCTIONS menu

Some functions of this unit can be operated from the FUNCTIONS menu.

1 Press [FUNCTIONS].

- Items to be displayed may vary with the media.

2 Press [▲, ▼] to select the item and press [OK].

- Playback
- Top Menu
- Menu
- Viewing Picture
- To Others

"Playlists":

You can play playlists created on DVD-VR.

Press [▲, ▼, ◀, ▶] to select the playlist and press [OK].

"Setup" (⇒ 29)

"Card Management" (⇒ 19)

Displays Home screen of VIERA CAST (⇒ above)

Switches to the disc drive.

Switches to the SD drive.

Switches to the USB drive.

- Network
- BD/DVD/CD
- SD card
- USB device

e.g.,

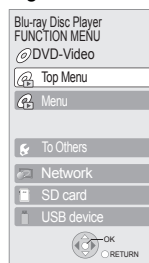

Changing settings with the on-screen menu

On-screen menu operations

- 1 Press [DISPLAY].
- 2 Press [▲, ▼] to select the menu and press [▶].
- 3 Press [▲, ▼] to select the item and press [▶].
- 4 Press [▲, ▼] to select the setting.

e.g., BD-Video

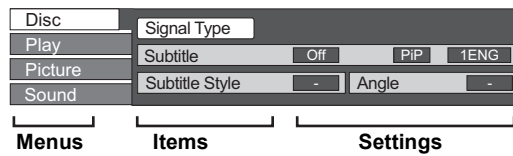

NOTE

- Depending on the condition of the unit (playing, stopped, etc.) and media contents, there may be some items that you cannot select or change.



TIPS

- Some items can be changed by pressing [OK].

To exit the on-screen menu
Press [DISPLAY].

What you can change with the on-screen menu

Menus	Items	Settings and details
Disc	Signal Type	BD-V <ul style="list-style-type: none"> • Primary Video Video: The video recording method appears. (⇒ below, Video attribute) Soundtrack: Select the type of audio or language. (⇒ below, Language, Audio attribute) • Secondary Video Video: Select on/off of images. The video recording method appears. (⇒ below, Video attribute) Soundtrack: Select on/off of audio and the language. (⇒ below, Language, Audio attribute)
	Video	AVCHD The video recording method appears. (⇒ below, Video attribute)
	Soundtrack	AVCHD DVD-V Select the type of audio or language. (⇒ below, Language, Audio attribute) DVD-VR MPEG2 The audio attributes appear. (⇒ below, Audio attribute) DivX Select the soundtrack number. • Soundtrack numbers are displayed even when there is only one audio type.
	Subtitle	BD-V AVCHD DVD-V Turn the subtitle on/off and select the language. (⇒ below, Language) DVD-VR (Only discs that contain subtitle on/off information) Turn the subtitle on/off. DivX Turn the subtitle on/off and select "Text" or the subtitle number. • Subtitle number is displayed even if there are not multiple subtitles.
	Subtitle Style	BD-V Select the subtitle style.
	Audio channel	DVD-VR DivX MPEG2 (⇒ 18, Changing audio during play)
	Angle	BD-V DVD-V Select the number of the angle.

Some items may be changed only on the disc specific menu. (⇒ 16)

Language

ENG: English	SVE: Swedish	CHI: Chinese	CES: Czech
FRA: French	NOR: Norwegian	KOR: Korean	SLK: Slovak
DEU: German	DAN: Danish	MAL: Malay	HUN: Hungarian
ITA: Italian	POR: Portuguese	VIE: Vietnamese	FIN: Finnish
ESP: Spanish	RUS: Russian	THA: Thai	*: Others
NLD: Dutch	JPN: Japanese	POL: Polish	

Audio attribute

LPCM/ <input type="checkbox"/> Digital/ <input type="checkbox"/> Digital+/ <input type="checkbox"/> TrueHD/DTS/DTS 96/DTS-HD HI RES/DTS-HD MSTR/MPEG	Signal type
ch (channel)	Number of channels
k (kHz)	Sampling frequency
b (bit)	Number of bits
bps (bit per second)	Transfer rate of bit

Video attribute

MPEG-2/MPEG-4 AVC/VC-1	Video recording method
480/576/720/1080	Video Format
24p/50i/60i/50p/60p	Video Frame rate
YCbCr4:2:2/YCbCr4:4:4/RGB	Color Space
bps (bit per second)	Transfer rate of bit

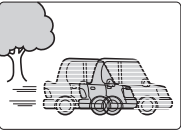
Menus	Items	Settings and details
Play	Repeat Play	(Only when the elapsed time is being displayed on the unit's display.) Selects the item which you want to repeat. The items displayed differ depending on the type of media. <ul style="list-style-type: none"> • All tracks All tracks • Chapter Chapter • Playlists Playlist • Title Title • One track Track • Off Select "Off" to cancel.
	Random	CD MP3 While playing, press [▲, ▼] to select "On". Random playback starts from the next track. <ul style="list-style-type: none"> • On • Off
	Playback Information Window BD80	BD-V DVD-V Displays audio/video attribute information of disc (Ⓞ), settings status of "Digital Audio Output" (⇒30) (Ⓜ) and HDMI output information (HDMI). (⇒26 Audio attribute, Video attribute) – Depending on the disc, display method may be different. – The audio attribute information will be displayed following the "Digital Audio Output" settings. (⇒ 20) Press [RETURN] to exit.
Picture	Mode	BD-V AVCHD DVD-VR DVD-V DivX MPEG2 Select the picture quality mode during play. <ul style="list-style-type: none"> • Normal: Default setting • Soft: Soft picture with smoother video • Fine: Details are sharper • Cinema: Mellows movies, enhances detail in dark scenes. • User: You can make further adjustments. (⇒ below) <ol style="list-style-type: none"> ① Press [▶] to select "Picture Adjustment" and press [OK]. ② Select the item using [▲, ▼] and adjust it with [◀, ▶]. Contrast: Increases the contrast between light and dark parts of the picture (–7 to +7). Brightness: Brightens the picture (0 to +15). Sharpness: Adjusts the sharpness of the edges of the horizontal lines (–6 to +6). Colour: Adjusts the shade of the picture's color (–7 to +7). Gamma: Adjusts the brightness of dark portions of the screen (0 to +5). 3D NR: Reduces the rough noise in the background to give a greater feeling of depth (0 to +4). Integrated NR: When "24p Output" is set to "On", this function may not operate. (⇒ 31) Smooths block noise and reduces the smudging that appears around contrasting sections of the picture (0 to +3).
	Progressive	Select the method of conversion for progressive output to suit the type of material being played (⇒ 42, Film and video). <ul style="list-style-type: none"> • Auto: Automatically detects the film and video content, and appropriately converts it. • Video: Select when using "Auto" and the content is distorted. • Film: Select this if the edges of the film content appear jagged or rough when "Auto" is selected. However, if the video content is distorted as shown in the illustration to the right, then select "Auto". 
	24p DVD-V	<ul style="list-style-type: none"> • On • Off Only when you have selected "On" in "24p Output" (⇒ 31) and play discs recorded at a rate of 60 fields per second.
Sound	Sound Effects*1,2	<ul style="list-style-type: none"> • Off Re-master (⇒ 18) <ul style="list-style-type: none"> • Re-master 1 • Re-master 2 • Re-master 3 V. Surround BD-V AVCHD DVD-VR DVD-V DivX MPEG2 (2 channels or more only) Enjoy a surround-like effect if you are using two front speakers only. – Turn V. Surround off if it causes distortion. – Do not use in combination with surround effects on other equipment. – V. Surround does not work for bilingual recordings. <ul style="list-style-type: none"> • V. Surround 1 • V. Surround 2
		Night Surround To enjoy a movie with powerful sound even when the volume is kept low at night, the audio is set in such a way that it can be heard easily. <ul style="list-style-type: none"> • Night Surround
		Dialog Enhancer*1 BD-V AVCHD DVD-VR DVD-V DivX MPEG2 (3 channels or more only, including a center channel) The volume of the center channel is raised to make dialog easier to hear. <ul style="list-style-type: none"> • On • Off
		High Clarity Sound BD80 When the analog video terminal is not being used, the electrical current that flows through the analog video circuit can be stopped. This prevents adverse effects on the audio signals and produces clearer sound. Use this when outputting image via HDMI terminal. Analog image will not be output via COMPONENT VIDEO OUT terminal or VIDEO OUT terminal. <ul style="list-style-type: none"> • On • Off Only when you have selected "Enable" in "High Clarity Sound" (⇒ 30)

*1 This function is effective for audio from the HDMI terminal or the DIGITAL AUDIO OUT terminal only when "Dolby D/Dolby D +/Dolby TrueHD" or "DTS/DTS-HD" is set to "PCM". (However, in this case, audio is output as 2ch from the DIGITAL AUDIO OUT terminal.)

*2 Not every function can be set individually.

Linked operations with the TV

(VIERA Link “HDAVI Control™”)

What is VIERA Link “HDAVI Control”?

VIERA Link “HDAVI Control” is a convenient function that offers linked operations of this unit, and a Panasonic TV (VIERA) or other device under “HDAVI Control”.

You can use this function by connecting the equipment with an HDMI cable. See the operating instructions for connected equipment for operational details.

- VIERA Link “HDAVI Control”, based on the control functions provided by HDMI which is an industry standard known as HDMI CEC (Consumer Electronics Control), is a unique function that we have developed and added. As such, its operation with other manufacturers’ equipment that supports HDMI CEC cannot be guaranteed.

- This unit supports “HDAVI Control 4” function.

“HDAVI Control 4” is the newest standard (current as of December, 2008) for Panasonic’s HDAVI Control compatible equipment. This standard is compatible with Panasonic’s conventional HDAVI equipment.

- Please refer to individual manuals for other manufacturers’ equipment supporting VIERA Link function.

What you can do with “HDAVI Control”

Automatic input switching

When the following operations are performed, the television will automatically switch the input channel and display the corresponding action.

- When play starts on the unit
- When an action that uses the display screen is performed (e.g., Direct Navigator screen)

- **BD-V DVD-V** When playback stops, the TV will automatically return to TV tuner mode.

Power on link

When the television is off and the following operations are performed, the television will automatically turn on and display the corresponding action.

- When play starts on the unit
- When an action that uses the display screen is performed (e.g., Direct Navigator screen)

Preparation

- 1) Connect this unit to your TV or other device with an HDMI cable (⇒ 8, 9).
- 2) Set “VIERA Link” to “On” (⇒ 31). (The default setting is “On”.)
- 3) Set the “HDAVI Control” operations on the connected equipment (e.g., TV).
- 4) Turn on all “HDAVI Control” compatible equipment and select this unit’s input channel on the connected TV so that the “HDAVI Control” function works properly.

Also when the connection or settings are changed, repeat this procedure.

Power off link

All connected equipment compatible with “HDAVI Control”, including this unit, automatically turns off when you switch the television off.

- This unit automatically turns off even during playback or any other operation.

About the Standby Power Save function

It is possible to minimize the stand-by power of this unit by the Power off link, even if the “Quick Start” of this unit is set to “On” (⇒ 32).

- “Standby Power Save” setting is required to be activated on the TV.
- When turning this unit on or off without using Power off link function, it is impossible to minimize the stand-by power of this unit.

Playing music continuously even after turning off power to the television (⇒ 21)



- When [▶] (PLAY) is pressed on this unit for “Automatic input switching” or “Power on link”, the playback image is not immediately displayed on the screen and it may not be possible to watch the contents from where playback started. In this case, press [◀◀] or [◀] to go back to where playback started.

Easy control only with VIERA remote control

If you connect this unit to a TV that has “HDAVI Control 2” or later with an HDMI cable, you can operate this unit using buttons on the TV remote control.

The buttons that you can use for this unit vary depending on the TV. For details, refer to the operating instructions of the TV.

Use the remote control supplied with this unit if you cannot operate this unit using buttons on the TV remote control.

- The operation of this unit may be interrupted when you press incompatible buttons on the TV remote control.

Using the FUNCTIONS menu to operate this unit

By using the TV remote control, you can play media using the FUNCTIONS menu.

- 1 Press the button for VIERA Link on the remote control.

- 2 Select the player.

- The FUNCTIONS menu is displayed.

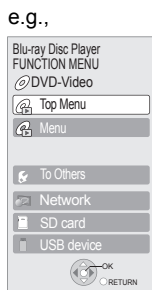

Using the OPTION menu to operate this unit

By using the TV remote control, you can play discs using the “Control Panel” and display the Top Menu (for BD-Video and DVD-Video) or Pop-up Menu (for BD-Video).

- 1 Press [OPTION].

This can also be displayed by using the VIERA menu screen.

Note You cannot use the OPTION menu while the Top Menu for BD-Video or DVD-Video is displayed.

- 2 Select an item, then press [OK].

e.g.,

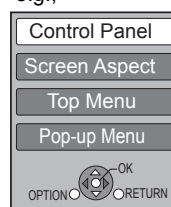

Control Panel	Control Panel is displayed. Follow the indications on the screen.
Screen Aspect	(⇒ 17)
Top Menu BD-V AVCHD DVD-V	Top menu is displayed.
Menu DVD-V	Menu is displayed.
Pop-up Menu BD-V	Pop-up menu is displayed.
Rotate RIGHT JPEG	Rotate the still picture.
Rotate LEFT JPEG	
Zoom in JPEG	Enlarge or reduce the still picture.
Zoom out JPEG	

■ **When you want to leave the TV on and set only this unit to standby mode**

Press [⏻] on this unit’s remote control and set to standby mode.

■ **When not using “HDAVI Control”**

Set “VIERA Link” in the Setup menu to “Off”. (⇒ 31)

Changing the unit's settings

Change the unit's settings if necessary. The settings remain intact even if you switch the unit to standby.

Setup menu operations

- 1 While stopped
Press [SETUP].
- 2 Press [▲, ▼] to select the menu and press [OK].
- 3 Press [▲, ▼] to select the item and press [OK].
If there are any other items, repeat these steps.
- 4 Press [▲, ▼, ◀, ▶] to select the option and press [OK].

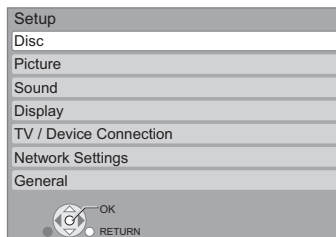

NOTE
• There may be differences in operation methods. If this happens, follow the on-screen instructions for the operation.



TIPS
To return to the previous screen
Press [RETURN].
To exit the screen
Press [SETUP].

Summary of settings

Underlined items are the factory presets.

“Disc”

DVD-Video Ratings Set a ratings level to limit DVD-Video play.	Follow the on-screen instructions. Enter a 4-digit password with the numbered buttons when the password screen is shown. It will be the common password for “DVD-Video Ratings”, “BD-Video Ratings” and “Network Lock”. • Do not forget your password.	<ul style="list-style-type: none"> • <u>8 No Limit:</u> All DVD-Video can be played. • 1 to 7: Prohibits play of DVD-Video with corresponding ratings recorded on them. • 0 Lock All: Prohibits play of all DVD-Video. Changing settings (When level 0 to 7 is selected) <ul style="list-style-type: none"> • Unlock Player • Change Level • Change Password • Temporary Unlock
BD-Video Ratings Set an age limit of BD-Video play.		<ul style="list-style-type: none"> • <u>No Limit:</u> All BD-Video can be played. • 0 to 254 year(s): Prohibits play of BD-Video with corresponding ratings recorded on them. Changing settings (When 0 to 254 year(s) is selected) <ul style="list-style-type: none"> • Unlock Player • Change Level • Change Password • Temporary Unlock
Soundtrack Preference Choose the language for audio, subtitle and disc menus. BD-V DVD-V	<ul style="list-style-type: none"> • Some discs start in a certain language despite any changes you make here. • When the selected language is not available on the disc, the default language is played. There are discs where you can only switch the language from the menu screen. (⇒ 16) • Enter a code (⇒ 45) with the numbered buttons when you select “Other *****”. 	<ul style="list-style-type: none"> • <u>English</u> • Italian • Original: The original language of each disc will be selected. • Other ***** • German • Spanish • French • Dutch
Subtitle Preference		<ul style="list-style-type: none"> • <u>Automatic:</u> If the language selected for “Soundtrack Preference” is not available, subtitles of that language will automatically appear if available on that disc. • English • Italian • Other ***** • German • Spanish • French • Dutch
Menu Preference		<ul style="list-style-type: none"> • <u>English</u> • Italian • Other ***** • German • Spanish • French • Dutch
BD-Live Internet Access BD-V (⇒ 19) You can restrict Internet access when BD-Live functions are used.		<ul style="list-style-type: none"> • <u>Permit:</u> Internet access is permitted for all BD-Live contents. Internet access is permitted only for BD-Live contents which have content owner certificates. Internet access is prohibited for all BD-Live contents without a certificate. • <u>Limit:</u> Internet access is permitted for all BD-Live contents. Internet access is prohibited for all BD-Live contents. • <u>Prohibit:</u> Internet access is permitted for all BD-Live contents. Internet access is prohibited for all BD-Live contents.
DivX Subtitle Text DivX Select a suitable item according to the language used for DivX subtitles text (⇒ 24). <ul style="list-style-type: none"> • This item is displayed only when pressing [SETUP] after playing back a file. 		<ul style="list-style-type: none"> • <u>Latin 1</u> • <u>Latin 2</u> • Cyrillic • English, German, Spanish, etc. • Polish, Czech, Hungarian, etc. • Russian, etc.

“Picture”

Still Mode BD-V AVCHD DVD-V Select the type of picture shown when you pause playback (⇒ 42, Frames and fields).		<ul style="list-style-type: none"> • <u>Automatic</u> • <u>Field:</u> Select if jittering occurs when “Automatic” is selected. (The picture is coarser.) • <u>Frame:</u> Select if small text or fine patterns cannot be seen clearly when “Automatic” is selected. (The picture is clearer and finer.)
Seamless Play DVD-VR Select the play mode between playlist chapter segments and partially deleted titles.		<ul style="list-style-type: none"> • <u>On:</u> The chapters in playlists are played seamlessly. This does not work while searching or when there are several audio types included on the playlist. Additionally, the positioning of chapter segments may change slightly. • <u>Off:</u> The points where chapters in playlists change are played accurately, but the picture may freeze for a moment.
NTSC Contents Output Select PAL60 or NTSC output when playing NTSC discs.		<ul style="list-style-type: none"> • <u>NTSC:</u> NTSC discs are played as NTSC. • <u>PAL60:</u> Select if picture is not displayed correctly when “NTSC” is selected.

“Sound”

Dynamic Range Compression BD-V AVCHD DVD-V DivX (Dolby Digital, Dolby Digital Plus and Dolby TrueHD only) Change the dynamic range (⇒ 42) for late night viewing.		<ul style="list-style-type: none"> ● On ● Off ● Auto: Effective only when Dolby TrueHD is played.
Digital Audio Output (⇒ 20) ● Press [OK] to show the following settings.		
Dolby D/Dolby D +/ Dolby TrueHD DTS/DTS-HD	Select whether Dolby Digital, Dolby Digital Plus, Dolby TrueHD, DTS Digital Surround, DTS-HD High Resolution Audio or DTS-HD Master Audio is output in “Bitstream” or “PCM” format. Note ● Not making the proper settings may result in noise. ● If the unit is connected with the HDMI AV OUT terminal, the specifications of the connected equipment take preference over this unit and audio selected in these items may not be output (e.g., when a television is connected, the HDMI audio output of this unit is limited to down-mixed 2ch.)	<ul style="list-style-type: none"> ● Bitstream: Select “Bitstream” when the connected equipment can decode the respective audio format. – Connect equipment supporting HDMI (High Bit rate Audio) and use a High Speed HDMI Cable in order to output high bit rate audio such as Dolby Digital Plus, Dolby TrueHD, DTS-HD High Resolution Audio or DTS-HD Master Audio. ● PCM: Select “PCM” when the connected equipment cannot decode the respective audio format. <p>Refer to the operating instructions for connected devices to verify whether or not they can decode each of the audio formats.</p>
MPEG Audio		<ul style="list-style-type: none"> ● Bitstream: When connected to equipment with a built-in MPEG decoder. ● PCM: When connected to equipment without a built-in MPEG decoder.
BD-Video Secondary Audio BD-V Turn on/off the clicking sound on the menu and audio with secondary video in picture-in-picture mode. (⇒ 19)		<ul style="list-style-type: none"> ● On: The primary audio and secondary audio are mixed and output. The sampling frequency is converted to 48 kHz. ● Off: The clicking sound on the menu and secondary audio are not output.
PCM Down Conversion Select how to output audio with a sampling frequency of 96 kHz. ● Signals are converted to 48 kHz despite the settings across in the following cases: – when the signals have a sampling frequency of 192 kHz – when the disc has copy protection – when “BD-Video Secondary Audio” is set to “On”		<ul style="list-style-type: none"> ● On: Signals are converted to 48 kHz. (Choose when the connected equipment cannot process signals with sampling frequency of 96 kHz.) ● Off: Signals are output as 96 kHz. (Choose when the connected equipment can process signals with sampling frequency of 96 kHz.)
Downmix Switch the downmix system for playing back multi-channel surround sound. ● When “Dolby D/Dolby D +/Dolby TrueHD” or “DTS/DTS-HD” is set to “Bitstream”, there are no downmix effects for the outputted audio. ● The audio will be outputted in “Stereo” in the following cases. – AVCHD playback – Playback of clicking sound on the menu and audio with secondary video in picture-in-picture mode		<ul style="list-style-type: none"> ● Stereo: When connected to equipment that does not support the virtual surround function. ● Surround encoded: When connected to equipment that supports the virtual surround function.
High Clarity Sound BD80 When the analog video terminal is not being used, the electrical current that flows through the analog video circuit can be stopped. This prevents adverse effects on the audio signals and produces clearer sound. ● Set to “Enable” and then set “High Clarity Sound” on the on-screen menu to “On”. (⇒ 27) ● Use this when outputting image via HDMI terminal. Analog image will not be output via COMPONENT VIDEO OUT terminal or VIDEO OUT terminal.	<ul style="list-style-type: none"> ● Enable ● Disable 	

“Display”

On-Screen Messages Choose whether to show status messages automatically.	<ul style="list-style-type: none"> ● Automatic ● Off
On-Screen Language Choose the language for these menus and on-screen messages.	<ul style="list-style-type: none"> ● English ● Français ● Español ● Deutsch ● Italiano ● Nederlands
Screen Saver Function This is to prevent burn-in on the screen. ● When this is set to “On”, the masked-off area on the screen becomes gray. [Only when connecting with an HDMI cable or a component video cable and “HDMI Video Format” (⇒ 31) is set to any other mode than “576p/480p”, or “Component Resolution” (⇒ 31) is set to “720p” or “1080i”]	<ul style="list-style-type: none"> ● On: If there is no operation for 10 minutes or more, the displayed screen switches to the other states automatically. – When the Direct Navigator or FUNCTIONS menu is displayed, the display returns to the screen saver mode. – When CD or MP3 is played, the display returns to the screen saver mode. (Playback continues.) – When still pictures are shown (except for slideshow), the display returns to the Direct Navigator screen. ● Off
FL Display Changes the brightness of the unit’s display.	<ul style="list-style-type: none"> ● Bright ● Dim: The display is dimmed. ● Automatic: The display is dimmed during playback and bright except playback.
SD Card LED Control Set the lighting method for the lamp on the SD card slot.	<ul style="list-style-type: none"> ● On ● SD inserted: When this unit is turned on and SD card is inserted, the lamp is lighted. ● Off
Software Licence	Information about the software used by this unit is displayed.

“TV/Device Connection”

<p>TV Aspect Set to match the type of television connected.</p>	<p>When connected to a 4:3 aspect television:</p> <ul style="list-style-type: none"> ● 4:3 Pan & Scan: Video recorded for a widescreen is played as Pan & Scan (unless prohibited by the producer of the disc). When playing BD-Video, video is output as “4:3 Letterbox”. ● 4:3 Letterbox: Video recorded for a widescreen is played in the letterbox style. <p>When connected to a 16:9 widescreen television:</p> <ul style="list-style-type: none"> ● 16:9: Video recorded for 4:3 aspect screen is displayed as a 4:3 ratio image in the center of the screen. ● 16:9 full: Video recorded for 4:3 aspect screen is displayed as a horizontally stretched 16:9 image.
<p>HDMI Connection ● Press [OK] to show the following settings.</p>	
<p>HDMI Video Mode Select “On” when video is output from HDMI AV OUT terminal.</p>	<ul style="list-style-type: none"> ● On: Images are output from the HDMI terminal in the resolution set in “HDMI Video Format”. Video from COMPONENT VIDEO OUT terminal is output as “576i/480i”. ● Off: Images are output in the resolution set in “Component Resolution”.
<p>HDMI Video Format* The items supported by the connected devices are indicated on the screen as “*”. When any item without “*” is selected, the images may be distorted.</p>	<ul style="list-style-type: none"> ● Automatic: Automatically selects the output resolution best suited to the connected television (1080p, 1080i, 720p or 576p/480p). ● 576p/480p ● 1080i ● 720p ● 1080p <p>– When outputting 1080p signal, we recommend using High Speed HDMI Cables that have the HDMI logo (as shown on the cover) and are less than 5.0 meters to prevent video distortion etc.</p> <p>– When the unit is connected to an amplifier/receiver that does not support the resolution set on the unit, the video cannot be output properly. In this case, use the HDMI cable to connect the unit to the TV and then connect the unit to the amplifier/receiver using a cable other than HDMI.</p> <p>– To enjoy high definition video up-converted to 1080p, you need to connect the unit directly to 1080p compatible HDTV (High Definition Television). If this unit is connected to an HDTV through other equipment, it must also be 1080p compatible.</p>
<p>24p Output BD-V DVD-V When this unit is connected to a TV supporting 1080/24p output via an HDMI cable, this unit displays each frame at 1/24 second intervals – the same interval originally shot with the film camera.</p> <ul style="list-style-type: none"> ● When playing DVD-Video, set to “On” and then set “24p” in “Picture” (⇒ 27) to “On” 	<ul style="list-style-type: none"> ● On: Images in 24p are output in 24p as they are. However, <ul style="list-style-type: none"> – when video is being output at 24 frames, images from any other terminal than the HDMI terminal may not be output properly. – BD-V: when images other than 24p are played, images are output at 60p. ● Off:
<p>HDMI Output Range Effective when connected to a device that only supports RGB output.</p>	<ul style="list-style-type: none"> ● Standard: The video is output as it is. ● Enhanced: When the black and white contrast of a video is low, the signal is enhanced to reproduce clear video.
<p>HDMI Audio Output This setting selects whether or not to output audio from HDMI.</p>	<ul style="list-style-type: none"> ● On: ● Off: When the TV is connected to this unit using an HDMI cable, and this unit is also connected to other devices, such as an amplifier/receiver using an optical digital audio cable or a coaxial cable (BD80).
<p>VIERA Link Set to use “HDAVI Control” function when connected with an HDMI cable to a device that supports “HDAVI Control”.</p>	<ul style="list-style-type: none"> ● On: ● Off: Select when you do not want to use “HDAVI Control”.
<p>Component Resolution* This sets the video output resolution when using the component video terminal.</p>	<ul style="list-style-type: none"> ● 576i/480i ● 576p/480p ● 720p ● 1080i <p>480i, 480p: When playing NTSC discs 576i, 576p: When playing PAL discs</p> <p>Even if you select “720p” or “1080i”, the video output resolution is restricted to “576p/480p” when DVD-Video discs, DivX and BD-Video discs recorded at a rate of 50 field per second are output from the COMPONENT VIDEO OUT terminals.</p>
<p>Analog Audio Output BD80 When connected with AUDIO OUT terminals, you can set the unit to output the best possible sound for your speakers.</p>	<ul style="list-style-type: none"> ● 2ch (Downmix) + 5.1ch: When connecting to 2ch AUDIO OUT or 5.1ch AUDIO OUT. (⇒ 33) ● 7.1ch: When connecting to 7.1ch AUDIO OUT. (⇒ 33)
<p>TV System Change the setting to match the equipment you are connecting with.</p> <ul style="list-style-type: none"> ● If picture output is not smooth, change the setting. ● When NTSC contents are played, they are outputted in the signal format specified in the “NTSC Contents Output”, irrespective of the settings here. 	<ul style="list-style-type: none"> ● NTSC: Select when connecting to a NTSC television. ● PAL: Select when connecting to a PAL or multi-system television.

* In this unit, a P4HD (⇒ 43) video processor is used to provide video of optimal resolution to the connected TV.

“Network Settings”

IP Address / DNS Settings (⇨ 14)		
● Press [OK] to show the following settings.		
Connection Test	— — — — —	
IP Address Auto-Assignment	● <u>On</u>	● Off
IP Address	— — — — . — — — — . — — — — . — — — —	
Subnet Mask	— — — — . — — — — . — — — — . — — — —	
Gateway Address	— — — — . — — — — . — — — — . — — — —	
DNS-IP Auto-Assignment	● <u>On</u>	● Off
Primary DNS	— — — — . — — — — . — — — — . — — — —	
Secondary DNS	— — — — . — — — — . — — — — . — — — —	
Connection Speed Auto-Config	● <u>On</u>	● Off
Connection Speed Setting	● 10BASE Half Duplex	● 10BASE Full Duplex
This is enabled only when “Connection Speed Auto-Config” is turned “Off”.	● 100BASE Half Duplex	● 100BASE Full Duplex
Proxy Server Settings (⇨ 15)		
● Press [OK] to show the following settings.		
Initialize	● Yes	● <u>No</u>
Proxy Address	(The initial setting is blank.)	
Proxy Port Number	(The initial setting is “0”.)	
Connection Test	— — — — —	
Network Service (⇨ 25) (VIERA CAST)		
● Press [OK] to show the following settings.		
Network Lock	● On	● <u>Off</u>
You can restrict using VIERA CAST. Follow the on-screen instructions. Enter a 4-digit password with the numbered buttons when the password screen is shown. It will be the common password for “DVD-Video Ratings”, “BD-Video Ratings” and “Network Lock”.	Changing settings (When “On” is selected)	
● Do not forget your password.	● Change Password	
Audio Auto Gain Control	● <u>On</u>	● Off
Volume that is different depending on the contents is adjusted automatically to the standard volume while using the VIERA CAST.		
● Depending on contents, this function effect will not work. ● Select “Off” when the audio is warped.		
Reduced Screen Display	● On	● <u>Off</u>
The screen is displayed reduced so the displayed screen of the VIERA CAST does not get truncated.		
Time Zone	● GMT -12 to +12	● GMT +1= CET (Central European Time)
By selecting the time zone, it is possible to set the unit’s time to match your location.	(For Continental Europe: The initial setting is “+1”.) (For the United Kingdom: The initial setting is “0”.)	
● Some VIERA CAST contents require the time zone to be set. Set the time zone if necessary.	GMT 0 = WET (Western European Time) GMT +1 = CET (Central European Time) GMT +2 = EET (Eastern European Time)	
Summer Time	● On	● <u>Off</u>
Select “On” when using Daylight Saving time.		
MAC Address (⇨ 14)		
Displays the “MAC Address” of this unit.		

“General”

Remote Control (⇨ 41)		
	● <u>Set Code 1</u>	● Set Code 2
		● Set Code 3
Quick Start	● On	● <u>Off</u>
Speed of startup from standby mode is increased.	Internal control unit will be powered when it is set to “On”, so contents of the following will be different from the time it is set to “Off”.	
● When the setting of “Standby Power Save” is enabled on the TV that supports HDAVI Control 4, it will take longer to startup this unit when the power supply of the TV is on standby mode even if the “Quick Start” is set to “On”.	● Idle power consumption will increase. (about the power consumption ⇨ 44) ● The cooling fan may turn slowly to prevent overheating of internal parts.	
Easy Setting	● Yes	● <u>No</u>
You can execute basic settings (“On-Screen Language”, “TV Aspect”, “Analog Audio Output” BD80 , and “Quick Start”).		
Default Settings	● Yes	● <u>No</u>
This returns all values in the Setup menu and the on-screen menu, except for “Remote Control”, “On-Screen Language”, “IP Address / DNS Settings”, “Proxy Server Settings”, “Network Service”, “DVD-Video Ratings” and “BD-Video Ratings” to the default settings.		
DivX Registration DivX (⇨ 24)		
You need this registration code to purchase and play DivX Video-on-Demand (VOD) content.		
Firmware Update (⇨ 13)		
● Press [OK] to show the following settings.		
Automatic Update Check	● <u>On</u>	● Off
When this equipment remains connected to the Internet, it will check for the latest firmware version when it is turned on and you can update it if necessary.		
Update Now	● Yes	● <u>No</u>
You can update the firmware manually.		

Changing the speaker setting to suit your speakers **BD80**

When connecting to an amplifier/receiver to enjoy multi-channel surround sound, use the following settings on this unit if they cannot be set on the amplifier/receiver.

The settings are effective when connecting to analog 7.1ch AUDIO OUT/5.1ch AUDIO OUT terminal.

Preparation

- Set "Analog Audio Output" to "7.1ch" or "2ch (Downmix) + 5.1ch".
(⇒ 31)
A message is displayed.
- Press [OK].

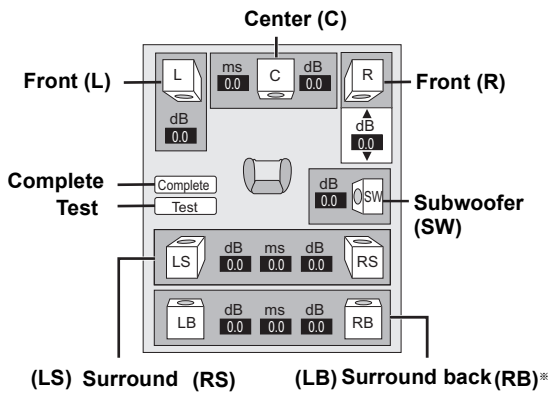

* Surround back channel is enabled only when setting "Analog Audio Output" to "7.1ch".

Speaker presence and size (L C R SW LS RS LB RB)

Set all the connected speakers individually.

- Press [▲, ▼, ◀, ▶] to select the speaker icon and press [OK].
- Press [▲, ▼] to select the setting and press [OK].

Icon examples:

- Surround speaker (LS)
- **Large:** Select when the speaker supports low-frequency (under 100 Hz) reproduction.
 - **Small:** Select when the speaker does not support low-frequency reproduction.

In order to make an ideal listening environment, settings of speaker sizes may be automatically adjusted.

For example, if the subwoofer is set to "No", the front speakers will automatically be set to "Large". (In this case, we recommend connecting a speaker that can reproduce bass below 100 Hz.)

Delay time (ms)

For optimum listening with 7.1/5.1-channel sound, all the speakers, except for the subwoofer, should be the same distance from the seating position.

If you have to place the center, surround and surround back speakers closer to the seating position, adjust the delay time to make up for the difference.

If either distance (A) or (C) is less than (B) (⇒ below) find the difference in the relevant table and change to the recommended setting.

- Press [▲, ▼, ◀, ▶] to select the delay time box (ms) and press [OK].

- Press [▲, ▼] to select the setting and press [OK].

5.1ch speaker connection

Approximate room dimensions

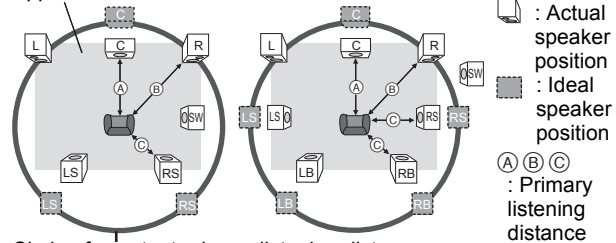

(A) Center speaker

Difference	Setting
Approx. 34 cm	1.0 ms
Approx. 68 cm	2.0 ms
Approx. 102 cm	3.0 ms
Approx. 136 cm	4.0 ms
Approx. 170 cm	5.0 ms

(C) Surround/Surround back speakers

Difference	Setting
Approx. 170 cm	5.0 ms
Approx. 340 cm	10.0 ms
Approx. 510 cm	15.0 ms

Channel balance (dB)

- Select "Test" and press [OK].
A test signal is output.
Front (L) → Center (C) → Front (R) → Surround (RS)
↑
Surround (LS) ← Surround Back (LB) ← Surround Back (RB)
- While listening to the test signal, press [▲, ▼] to adjust the volume of each speaker
Front speakers: 0.0 to -6.0 dB
Center speaker, Surround/Surround Back speakers: 0.0 to -12.0 dB
- Press [OK].
The test signal stops.
• No signal is output for the subwoofer. To adjust its volume, play something, then return to this screen to adjust to suit your taste.

To finish the speaker setting

Press [▲, ▼, ◀, ▶] to select "Complete" and press [OK].

About MP3/JPEG/DivX files

File format	MP3	JPEG
Playable media	CD-R*1, CD-RW*1, DVD-R*1,5, DVD-R DL*1,5, USB device	CD-R*1, CD-RW*1, DVD-RAM*2, DVD-R*1,5, DVD-R DL*1,5, BD-RE*3, SD card, USB device
Extension	Files must have the extension ".mp3" or ".MP3".	Files must have the extension ".jpg" or ".JPG".
Picture resolution	—	between 34×34 and 8192×8192 pixels (sub sampling is 4:2:2 or 4:2:0)
Compression rate	32 kbps to 320 kbps	—
Sampling rate	44.1 kHz/48 kHz	—
Reference	ID3 tags: version 1, 2.2, 2.3, 2.4 ID3 is a tag embedded in MP3 track to provide information about the track. This unit supports the versions listed above but only titles and the names of artists can be displayed. ● If there is a large amount of still picture data etc. within a MP3 file, play may not be possible.	JPEG conforming DCF*4 is supported. Thawing Time: approx. 2 sec. (7M pixels) ● MOTION JPEG and Progressive JPEG is not supported.

File format	DivX	Subtitles text file of DivX
Playable media	CD-R*1, CD-RW*1, DVD-R*1,5, DVD-R DL*1,5, USB device	CD-R*1, CD-RW*1, DVD-R*1,5, DVD-R DL*1,5, USB device
File format	—	MicroDVD, SubRip, or Tmplayer
Extension	Files must have the extension ".DIVX", ".divx", ".AVI" or ".avi".	Files must have the extension ".SRT", ".srt", ".SUB", ".sub", ".TXT", or ".txt"
Picture resolution	between 32×32 and 720×576 pixels	—
Reference	<ul style="list-style-type: none"> ● Certified to the DivX Home Theater Profile. Video <ul style="list-style-type: none"> – Number of stream: Up to 1 – Codec: DIV3, DIV4, DIVX, DV50, DIV6 – FPS (Frame Per Second): Up to 30 fps Audio <ul style="list-style-type: none"> – Number of stream: Up to 8 – Format: MP3, MPEG, Dolby Digital – Multi channel: Dolby Digital is possible. MPEG multi is 2 ch conversion. ● GMC (Global Motion Compensation) is not supported. 	<ul style="list-style-type: none"> ● The DivX video file and subtitles text file are inside the same folder, and the file names are the same except for the file extensions. ● If there are more than one subtitles text files inside the same folder, they are displayed in the following order of priority: ".srt", ".sub", ".txt". ● In the following situations, the subtitles cannot be displayed as recorded. Furthermore, depending on the methods used to create the file or the state of the recording, only parts of the subtitles may be displayed, or the subtitles may not be displayed at all. <ul style="list-style-type: none"> – When special text or characters are included in the subtitles text. – When the file size is larger than 256 KB. – When characters with specified styling are included in the subtitle data. – Codes that specify the character style within files are displayed as subtitle characters. – When data with a different format exists within the subtitle data. ● If the file name of the DivX video file is not displayed correctly on the menu screen (the file name is displayed as "_"), the subtitles text may not be displayed correctly. ● Depending on the disc, the subtitles text cannot be displayed when search and other such operations are being performed.

- English alphabet and Arabic numerals are displayed correctly. Other characters may not be displayed correctly.
- The display order on this unit may differ from how the order is displayed on a computer.
- Depending on how you create the media (writing software), files and folders may not play in the order you numbered them.
- Depending on how you create the structure of folders (writing software), files and folders may not play. (⇒ 35)
- This unit is not compatible with packet-write format.
- Depending on the recording conditions, the media may not play.
- Operation may take time to complete when there are many files and/or folders and some files may not display or be playable.

*1 ISO9660 level 1 or 2 (except for extended formats), Joliet

This unit is compatible with multi-session.

This unit is not compatible with packet writing.

*2 Discs must conform to UDF 2.0.

*3 Discs must conform to UDF 2.5.

*4 Design rule for Camera File system: unified standard established by Japan Electronics and Information Technology Industries Association (JEITA).

*5 Discs must conform to UDF bridge (UDF 1.02/ISO9660).

This unit is not compatible with multi-session.

The default session only is played.

■ Structure of folders that can play back on this unit
 You can play files on this unit by structure of folders as shown below. However depending on the method of writing data (writing software), play may not be in the order you numbered the folders.

 : Folder which can be displayed with this unit

***: Numbers

XXX: Letters

*1 ***: from 001 to 999

*2 ***: from 100 to 999

XXX: up to 5 figures

*3 ****: from 0001 to 9999

Structure of MP3 folders in DVD-R/DVD-R DL/CD-R/CD-RW/USB device

Prefix the file names with 3-digit numbers in the order you want to play them.

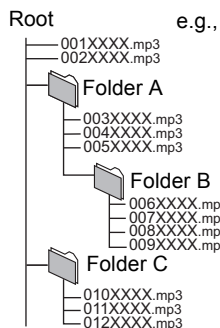

Structure of DivX folders in DVD-R/DVD-R DL/CD-R/CD-RW/USB device

Files inside a folder are displayed in the order they were updated or taken.

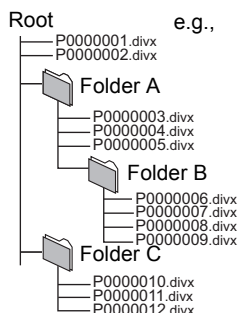

Structures of still picture (JPEG) folders

in DVD-R/DVD-R DL/CD-R/CD-RW

Files inside a folder are displayed in the order they were updated or taken.

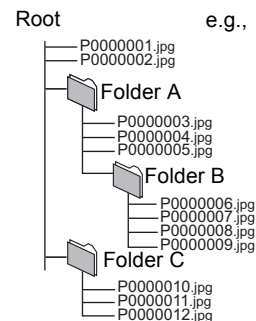

in BD-RE/DVD-RAM

• Folder structure is not displayed.

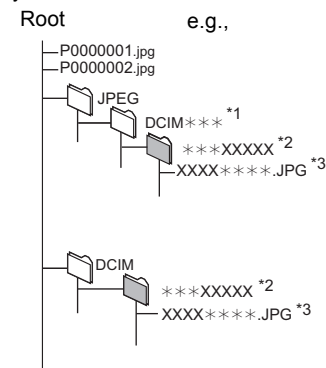

in SD card/USB device

Displays JPEG files in all folders.

• Folder structure is not displayed.

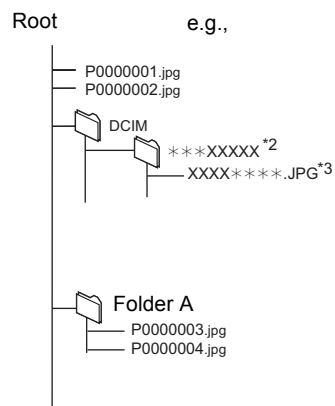

Messages

The following messages or service numbers appear on the television or unit's display when something unusual is detected during startup and use.

On the television		Page
Authorisation Error. This unit is not authorised to play this title.	<ul style="list-style-type: none"> ● DivX: You are trying to play the DivX VOD content that was purchased with a different registration code. You cannot play the content on this unit. 	24
Cannot play.	<ul style="list-style-type: none"> ● You inserted an incompatible disc. 	6, 7
Cannot play on this unit.	<ul style="list-style-type: none"> ● You tried to play a non-compatible image. ● Confirm "SD" on the unit's display is not blinking and re-insert the card. 	7, 34 —
No disc is inserted.	<ul style="list-style-type: none"> ● The disc may be upside down. 	—
Rental Expired.	<ul style="list-style-type: none"> ● DivX: The DivX VOD content has zero remaining plays. You cannot play it. 	24
⊘ This operation is not available.	<ul style="list-style-type: none"> ● Some operations are unsupported by the unit. For example; <ul style="list-style-type: none"> – BD-V: During play back, reverse slow-motion or reverse frame-by-frame is not possible. 	17
⊘ This operation is prohibited by this disc.	<ul style="list-style-type: none"> ● Depending on the disc, you may not be able to perform search or skip when film previews and warning screens are being played back. 	17
Cannot connect. Please check the connection of the LAN cable.	<ul style="list-style-type: none"> ● When a hub is used but its Link lamp does not light up, check the cable connection, LAN terminal connection, cable itself (a cross cable may be used by mistake), etc. 	13
IP address is not set.	<ul style="list-style-type: none"> ● The "IP Address" in "IP Address / DNS Settings" is "----. ----. ----. ----". Set the "IP Address", "Subnet Mask", and "Gateway Address". (Select the automatic address acquisition if necessary.) 	14
Cannot obtain IP address. Please check the connection or setting of the router.	<ul style="list-style-type: none"> ● If you use a hub, then check the connection between the hub and the router. <ul style="list-style-type: none"> – Use the UPLINK port of the hub to connect to a router. – Check whether or not the hub's Link lamp lights up. If it does not light up, then check the cable connection, LAN terminal connection, cable itself (a cross cable may be used by mistake), etc. ● If the above conditions are OK, then the router may not operate in DHCP mode. Check the router settings and operation. You may reset the router to restore it to normal. 	13 13
This IP address is already in use. Please check the setting.	<ul style="list-style-type: none"> ● This unit's IP address is used by another device. Check the IP addresses of this unit, personal computers, and routers, etc. If necessary, reconfigure them to avoid IP addresses from being duplicated. 	—
Connection test could not be conducted.	<ul style="list-style-type: none"> ● Turn the unit off. Remove the AC mains lead and reconnect it and try again. If the same symptom persists, then consult your dealer. 	—
IP address is not set correctly.		
Connection test was unsuccessful. No reply from Gateway. Please check the connection or setting of the router.	<ul style="list-style-type: none"> ● If you use a hub, then check the connection between the hub and the router. <ul style="list-style-type: none"> – Use the UPLINK port of the hub to connect to a router. – If the hub's Link lamp does not light up, then check the cable connection, LAN terminal connection, cable itself (a cross cable may be used by mistake), etc. ● Check the "IP Address", "Subnet Mask", and "Gateway Address" in the "IP Address / DNS Settings". ● If the MAC address information is required, then press [SETUP] to display the "Network Settings" menu. 	13 14 14
Network connection was rejected. Please confirm Setup "BD-Live Internet Access".	<ul style="list-style-type: none"> ● When you set "BD-Live Internet Access" to "Limit" and play BD-Live contents which do not have a content owner certificate, the Internet access of the content is not allowed. If you allow the content to connect to Internet, set "BD-Live Internet Access" to "Permit". 	29
Could not check for latest firmware version. Please try again later.	<ul style="list-style-type: none"> ● The firmware download server is currently unavailable. Please try again later. 	—
High Clarity Sound is effective. Analog video output is turned off when playback starts.	<ul style="list-style-type: none"> ● BD80: "High Clarity Sound" in setup menu is set to "Enable", and "High Clarity Sound" in on-screen menu is set to "On". 	27, 30

On the unit's display

Page

On the unit's display		Page
F99	<ul style="list-style-type: none"> The unit fails to operate properly. Press [⏻/] on the main unit to switch the unit to standby for 3 seconds. Now press [⏻/] on the main unit again to turn the unit on. 	—
HDMI ONLY	<ul style="list-style-type: none"> Some BD-Video discs can only be output with HDMI. 	—
NET	<ul style="list-style-type: none"> Displays while VIERA CAST is starting up. 	—
No PLAY	<ul style="list-style-type: none"> There is a viewing restriction on a BD-Video or DVD-Video. 	29
No READ	<ul style="list-style-type: none"> The media is dirty or badly scratched. The unit cannot play. 	—
PLEASE WAIT	<ul style="list-style-type: none"> The unit is carrying out internal process. This is not a malfunction. You cannot operate the unit while "PLEASE WAIT" is displayed. When connected to TV (VIERA) with HDAVI Control 4, and power supply is turned off by the "Intelligent Auto Standby" function on the TV side. 	—
REMOVE	<ul style="list-style-type: none"> The USB device is drawing too much power. Remove the USB device. 	16
SET □ (“ □ ” stands for a number.)	<ul style="list-style-type: none"> The remote control and main unit are using different codes. Change the code on the remote control.  <p>Press and hold [OK] and the indicated number button at the same time for more than 5 seconds.</p>	41
UNFORMAT	<ul style="list-style-type: none"> You inserted an unformatted DVD-RAM, DVD-RW, +RW, an unused +R, +R DL or DVD-RW (DVD-Video format). 	—
UNSUPPORT	<ul style="list-style-type: none"> You have inserted a media the unit cannot play. You tried to operate with a non-compatible USB device. 	6, 7 7
U59	<ul style="list-style-type: none"> The unit is hot. The unit switches to standby for safety reasons. Wait for about 30 minutes until the message disappears. Select a position with good ventilation when installing the unit. Do not block the cooling fan on the rear of the unit. 	—
U72 U73	<ul style="list-style-type: none"> The HDMI connection acts unusually. <ul style="list-style-type: none"> The connected equipment is not HDMI compatible. Please use HDMI cables that have the HDMI logo (as shown on the cover). The HDMI cable is damaged. 	—
H□□ or F□□	<ul style="list-style-type: none"> There is something unusual. (The service number displayed after H and F depends on the unit's condition.) Check the unit using the troubleshooting guide. If the service number does not disappear, do the following. <ol style="list-style-type: none"> Disconnect the plug from the household mains socket wait a few seconds, then reconnect it. Press [⏻/] to turn the power on. (The unit may be fixed.) If the service number does not disappear despite doing the above, request service from the dealer. Inform the dealer of the service number when requesting service. 	— 38–41
START	<ul style="list-style-type: none"> The system is being restarted during the firmware update. Please do not turn off power. 	13
UPD□/□	<ul style="list-style-type: none"> The firmware is being updated. 	13
FINISH	<ul style="list-style-type: none"> The firmware update is complete. 	13

Troubleshooting guide

Before requesting service, make the following checks. If you are in doubt about some of the check points, or if the solutions indicated in the chart do not solve the problem, consult your dealer for instructions.

The following do not indicate a problem with this unit:

- Regular disc rotating sounds.
- Image disturbance during search.

To reset this unit

		Page
To restore the unit if it freezes due to one of the safety devices being activated	● Press and hold [⏻/] on the main unit for 3 seconds. (The settings remain unchanged.)	—
To return all settings other than some settings to the factory preset	● Select “Yes” in “Default Settings” in the Setup menu. This returns all values in the Setup menu and the on-screen menu, except for “Remote Control”, “On-Screen Language”, “IP Address / DNS Settings”, “Proxy Server Settings”, “DVD-Video Ratings”, “BD-Video Ratings” and “Network Service” to the default settings.	32
To return to the factory preset (No setting)	● Reset the unit as follows: 1 Press [⏻/] on the unit to turn off the unit. 2 Press and hold [■] and press [⏻/] and [▲ OPEN/CLOSE] on the unit at the same time for more than 5 seconds until “HELLO” is displayed on the unit. 3 The power is turned on and then turned off automatically.	—

Power

No power.	● Insert the AC mains lead securely into a household mains socket.	10
The unit switches to standby mode.	● One of the unit’s safety devices is activated. Press [⏻/] on the main unit to turn the unit on.	—
Power of this unit is turned off when the input for the TV is switched.	● If connected with an HDAVI Control 4 compatible TV (VIERA) with the “Intelligent Auto Standby” setting activated on the TV, when switching the TV input, the unit will be automatically turned to standby. For details please read the operating instructions of the TV.	—

Operation

Cannot operate the television or amplifier/receiver. The remote control doesn’t work properly.	● Change the manufacturer code of the remote control. In some cases, even if you change the code, the remote control may not be operated depending on the type of the televisions or amplifier/receivers.		12
	● It may be necessary to set the manufacturer code or the remote control code again after changing the batteries for remote control.		12, 41
	● The remote control and main unit are using different codes. Change the code on the remote control. Press and hold [OK] and the indicated number button at the same time for more than 5 seconds.		41
	● The batteries are depleted. Replace them with new ones.		5
	● You are not pointing the remote control at the main unit’s remote control signal sensor during operation.		5
	● Colored glass may obstruct the signal reception/transmission. ● Don’t place the signal sensor in direct sunlight or in areas that may be subject to sunlight exposure.		—
The unit is on but cannot be operated.	● Confirm the correct drive is selected.		16
	● Some operations may be prohibited by the disc.		—
	● The unit is hot (“U59” appears on the display). Wait for “U59” to disappear.		37
	● One of the unit’s safety devices may have been activated. Reset the unit as follows: 1 Press [⏻/] on the main unit to switch the unit to standby. If the unit doesn’t switch to standby, press and hold [⏻/] on the main unit for about 3 seconds. The unit is forcibly switched to standby. Alternatively, disconnect the AC mains lead, wait one minute, then reconnect it. 2 Press [⏻/] on the main unit to switch it on. If the unit still cannot be operated, consult the dealer.		—
Play fails to start even when [▶] (PLAY) is pressed. Play starts but then stops immediately.	● Condensation has formed. Wait 1 to 2 hours for it to evaporate.		—
	● Insert the disc correctly with the label facing up.		16
	● The disc is dirty. ● You tried to play a blank disc or unplayable disc on this unit. ● DivX If playing DivX VOD content, refer to the homepage where you purchased it.		3 6, 7 24
Cannot eject disc.	● The unit may have a problem. While the unit is off, press and hold [■] and [▲ OPEN/CLOSE] on the main unit at the same time for about 5 seconds. Remove the disc and consult the dealer.		—
Startup is slow. It takes time before play starts.	● Make sure that “Quick Start” is set to “On”. If connected with an HDAVI Control 4 compatible TV (VIERA) with the “Standby Power Save” setting activated on the TV, even with “Quick Start” set to “On”, when the TV is in standby mode, the unit may take some time to startup.		32
	● Startup takes time in the following situations. – Immediately after a power failure or the AC mains lead is connected. – When the unit is connected with an HDMI cable.		—
	● DivX This is normal on DivX video.		—
Cannot set “On” in “24p Output”.	● Only when the unit is connected to the HDMI terminal of a TV supporting 24p you can select “On”. In some cases where the unit is connected to a TV via an amplifier/receiver through the HDMI terminals, you may not be able to select “On”. In this case, connect the unit to a TV through the HDMI terminal and connect it to the amplifier/receiver through any terminal other than HDMI.		31

The display is dim.	● Change “FL Display” in the Setup menu.	30
The elapsed time displayed is actually less than the play time.	● The displayed play time is converted from the number of frames at 29.97 frames (equal to 0.999 seconds) to one second. There will be a slight difference between the time displayed and the actual elapsed time (e.g., actual one-hour elapsed time may display as approximately 59 minutes 56 seconds).	—

TV screen and video

The images from this unit do not appear on the television.	● Make sure that the television is connected to the VIDEO OUT terminal, COMPONENT VIDEO OUT terminals or HDMI AV OUT terminal on this unit.	8, 9
Picture is distorted.	● Make sure that the television's input setting (e.g., AV 1) is correct.	—
	● An incorrect resolution is selected in “Component Resolution”, when the television is connected to COMPONENT VIDEO OUT terminals. While stopped, press and hold [■] and [▶] (PLAY) on the main unit at the same time for more than 5 seconds to cancel this setting. Set the item again.	31
	● If “24p Output” is set to “On” when the unit is connected to a TV through any terminal other than HDMI, images may not display properly. In this case, set “24p Output” to “Off”.	31
	● The unit and television are using different video systems. While stopped, keep pressing [■] and [▲ OPEN/CLOSE] on the main unit for 5 or more seconds. The system switches from PAL to NTSC or vice versa.	—
	● The system used on the disc doesn't match your television. – PAL discs cannot be correctly viewed on an NTSC television. – This unit can convert NTSC signals to PAL60 for viewing on a PAL television (“NTSC Contents Output” in the “Picture”).	29
	● DivX Images may not be output due to how files were created.	—
Played back image is distorted or does not playback correctly. (AVCHD)	● High definition video (transfer rate of 18 Mbps or faster) cannot be played back correctly if it was recorded on a DVD compatible to double speed or slower.	—
Picture stops.	● DivX Picture may stop if the DivX files are greater than 2 GB.	—
The screen changes automatically.	● When the “Screen Saver Function” in the Setup menu is set to “On”, the display may return to the screen saver mode automatically if there is no operation for 10 minutes or more.	30
Video is not output.	● An image is not output from the COMPONENT VIDEO OUT terminal or the VIDEO OUT terminal when the “High Clarity Sound” is enabled. Set the “High Clarity Sound” in the on-screen menu to “Off” to use the COMPONENT VIDEO OUT terminal or the VIDEO OUT terminal.	27
Video is not output in high definition.	● High definition video cannot be output through the VIDEO OUT terminal.	—
	● Confirm that the “HDMI Video Mode”, “HDMI Video Format”, and “Component Resolution” in the Setup menu are set properly.	31
	● The video output resolution is restricted to “576p/480p” when DVD-Video discs, DivX and BD-Video discs recorded at a rate of 50 field per second are output from the COMPONENT VIDEO OUT terminals.	—
Status messages do not appear.	● Select “Automatic” in “On-Screen Messages” in the Setup menu.	30
The 4:3 aspect ratio picture expands left and right.	● Use the television to change the aspect. Refer to your television's operating instructions.	—
Screen size is wrong.	● When using a component video cable, set “Progressive” to “Video”. If the situation is not restored after that, set “TV Aspect” to “4:3 Pan & Scan”.	27, 31
There is a lot of after-image when playing video.	● Turn “3D NR” or “Integrated NR” off if it is on.	27
There is no apparent change in picture quality when adjusted with the “Picture” menu in the on-screen menu.	● The effect is less perceivable with some types of video.	—
The masked-off area is masked in gray.	● If the “Screen Saver Function” in the Setup menu is set to “Off”, the masked-off area is displayed in black.	30
Still pictures (JPEG) do not playback normally.	● The images that were edited on the PC, such as Progressive JPEG, etc., may not playback.	34

Sound

Page

No sound. Low volume. Distorted sound. Cannot hear the desired audio type.	<ul style="list-style-type: none"> • Check the connections and the “Digital Audio Output” settings. Check the input mode on the amplifier/receiver if you have connected one. 	8–10, 30
	<ul style="list-style-type: none"> • Press [AUDIO] to select the audio. 	18
	<ul style="list-style-type: none"> • Turn off “V. Surround” in the following cases. <ul style="list-style-type: none"> – When using discs that do not have surround sound effects such as Karaoke discs. – When playing bilingual broadcast programs. 	27
	<ul style="list-style-type: none"> • BD80 When the unit is connected to an amplifier/receiver with the AUDIO OUT terminal, set “Analog Audio Output” and match multi channel speaker settings. If these are not set properly, the audio is not output correctly. 	31, 33
	<ul style="list-style-type: none"> • BD80 When connected to an amplifier/receiver or any other devices using both AUDIO OUT terminal and HDMI AV OUT terminal, the audio from AUDIO OUT terminal may not be output with the desired audio depending on the specifications of the connected devices, etc. Set “HDMI Audio Output” to “Off”, when you output multi-channel surround sound from AUDIO OUT terminal. • The sound effects (Re-master, V. Surround, etc.) will not work when the bitstream signal is output from the HDMI AV OUT terminal or the DIGITAL AUDIO OUT terminal. • DivX Audio may not be output depending on how files were created. 	31 — —
Cannot switch audio.	<ul style="list-style-type: none"> • There are discs for which audio cannot be changed because of how the disc was created. • When connecting an amplifier/receiver using a coaxial cable (BD80), optical digital audio cable or an HDMI cable, you cannot switch the audio if “Dolby D/Dolby D +/Dolby TrueHD” or “DTS/DTS-HD” is set to “Bitstream”. Set “Dolby D/Dolby D +/Dolby TrueHD” or “DTS/DTS-HD” to “PCM” or connect using AUDIO OUT terminal. 	— 9, 10, 30

HDMI connections

The images from this unit do not appear on the television.	<ul style="list-style-type: none"> • An incorrect resolution is selected in “HDMI Video Format”, when the television is connected to HDMI AV OUT terminals. While stopped, press and hold [■] and [▶] (PLAY) on the main unit at the same time for more than 5 seconds to cancel this setting. Set the item again. However, Dolby Digital Plus, Dolby TrueHD, and DTS-HD audio are not output in bitstream. To output the bitstream, select “Default Settings” to restore the factory presets and make proper settings. 	32
Picture is distorted.	<ul style="list-style-type: none"> • To output video from a device connected with an HDMI cable, set “HDMI Video Mode” to “On” in the Setup menu. 	31
Jittering occurs.	<ul style="list-style-type: none"> • Picture may not be seen when more than 4 devices are connected with HDMI cables. Reduce the number of connected devices. • When “24p Output” is set to “On”, HDMI authentication takes place where 24p images switch to other images, and a black screen is displayed. • When “24p Output” is set to “On”, jittering may occur while playing DVD-Video. In this case, turn “24p Output” to “Off”. 	— 31 31
The 4:3 aspect ratio picture expands left and right. Screen size is wrong.	<ul style="list-style-type: none"> • Change “TV Aspect” type to “16:9”. 	31
When playing DVD-Video using progressive output, one part of the picture momentarily appears to be doubled up.	<ul style="list-style-type: none"> • When you use the HDMI AV OUT terminal for video output, follow the steps below for setting. <ol style="list-style-type: none"> 1 Connect this unit to the TV with any cable except the HDMI cable. 2 When you connect with the Component Video cable, set “HDMI Video Mode” to “Off” and “Component Resolution” to “576i/480i” in the Setup menu. 	31
No sound. Low volume. Distorted sound. Cannot hear the desired audio type.	<ul style="list-style-type: none"> • Audio may not be heard when more than 4 devices are connected with HDMI cables. Reduce the number of connected devices. • The sound effects will not work when the bitstream signal is output from the HDMI AV OUT terminal or the DIGITAL AUDIO OUT terminal. • To output audio from a device connected with an HDMI cable, set “HDMI Audio Output” to “On” in the Setup menu. • Depending on the connected equipment, the sound may be distorted if this unit is connected with an HDMI cable. • When “BD-Video Secondary Audio” is set to “On”, Dolby Digital Plus, Dolby TrueHD, and DTS-HD are converted to 48 kHz Dolby Digital or DTS Digital Surround and output. LPCM 7.1 channel audio is converted to 5.1 channel audio. In this case, set the “BD-Video Secondary Audio” to “Off”. 	— — 31 — 30

Card

The capacity of the SD card decreased.	<ul style="list-style-type: none"> • When a BD-Video that supports the BD-Live is used, and an SD card is in the slot, data may be written to the SD card. Erase the data by using “BD-Video Data Erase”, format the card or use a new card. 	19
Music on an SD card cannot be played.	<ul style="list-style-type: none"> • Data that can be played from an SD card are AVCHD, MPEG2 and JPEG data. 	7
The contents of the card cannot be read.	<ul style="list-style-type: none"> • The card is not compatible or the contents on the card may be damaged. • Turn off and then turn on the unit again. 	7 —

USB

The contents of the USB device cannot be read.	<ul style="list-style-type: none"> • Remove the USB device from the USB port and then insert again. If this does not solve the problem, turn off and turn on the unit again. • Check that the USB device is inserted correctly. • The format of the USB device or of its contents is not compatible with the unit. (The contents on the USB device may be damaged.) • The USB device contains a folder structure and/or file extensions that are not compatible with this unit. • Turn off and then turn on the unit again. • USB memories connected using a USB extension cable or a USB hub may not be recognized by this unit. • Some USB devices cannot be used with this unit. • If inserted during playback the USB device may not be recognized by this unit. 	— 16 7 35 — — 7 —
USB device cannot be operated.	<ul style="list-style-type: none"> • Turn the power of this unit off once, and turn it back on. 	7

I can't connect to the network.	● Has the LAN cable come unplugged? Check that the LAN cable is properly connected.	13
	● Have you plugged in a modular cable for use with a telephone into the LAN terminal on this unit? Connect with a straight LAN cable.	13
	● Is the power for the modem or broadband router turned on? Turn the power on for each device.	—
	● Is there a mistake in the network settings? Follow any instructions you may have received from your ISP (Internet Service Provider) and make changes to the settings.	—
	● Are the broadband router settings correct? Read the operating instructions for the broadband router.	—
	● Is the broadband router and/or modem correctly connected? Check the operating instructions for each device and connect accordingly.	—
	● Check the "Network Settings" and "BD-Live Internet Access" settings.	29, 32
While using my PC, I cannot connect to the network.	● Does your Internet Service Provider (ISP) or service contract prevent multiple terminals connecting at the same time? Check the content of your contract.	—
VIERA CAST does not operate or connect.	● Is the network connection correct? ● Image of the video contents may be disturbed or may not display depending on how busy the environment or the connected line is.	13 —

Other difficulties with playback

Audio and video momentarily pause.	● This occurs between playlist chapters or scenes (AVCHD). ● When playing a title recorded on both layers, the unit automatically switches between layers and plays the title in the same way as a normal program. However, video and audio may momentarily cut out when the unit is switching layers.	— —
BD-Video or DVD-Video is not played.	● Ensure the disc is for the correct BD-Video region code or DVD-Video region number, and is not defective. ● You have set a ratings level to limit BD-Video or DVD-Video play. Change this setting. ● Some BD-Video can only be output with HDMI.	Cover 29 —
Picture-in-picture is not played with BD-Video.	● Confirm whether the disc supports picture-in-picture.	—
The BD-Live is not played with BD-Video.	● Confirm whether the disc supports the BD-Live. ● The inserted SD card does not have sufficient available capacity. ● The SD card is write-protected. ● Sub contents copied to an SD card are provided by the disc producer as a part of the BD-Video content. Even if you record images and audio onto an SD card, it cannot be played as a BD-Live.	19 — 7 19
Alternative soundtrack and subtitles cannot be selected.	● The languages are not recorded on the disc. ● You may not be able to use the on-screen menu to change the soundtrack and subtitles on some discs. Use the disc's menus to make changes.	— 16
No subtitles.	● Subtitles are not recorded on the disc. ● Turn the subtitles on. Set "Subtitle" on the on-screen menu to "On".	— 26
Angle cannot be changed.	● Angles can only be changed during scenes where different angles are recorded.	—
The resume play function does not work.	● Memorized positions are canceled when — pressing [■] several times. — opening the disc tray. ● The resume play function may not work depending on the disc. ● BD-V : On BD-Video discs including BD-J, the resume play function does not work.	— — —

When other Panasonic products respond to this remote control

Change the remote control code on the main unit and the remote control (the two must match) if you place other Panasonic products close together.

- 1 Press [SETUP].
- 2 Press [▲, ▼] to select "General" and press [OK].
- 3 Press [▲, ▼] to select "Remote Control" and press [OK].
- 4 Press [▲, ▼] to select the code (1, 2, or 3) and press [OK].
- 5 To change the code on the remote control
While pressing [OK], press and hold the numbered button ([1], [2] or [3]) for more than 5 seconds.
- 6 Press [OK].

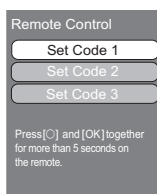

When the following indicator appears on the unit's display and you are unable to operate the unit



The unit's remote control code
Press and hold [OK] and the indicated number button at the same time for more than 5 seconds.

Glossary

AVCHD

AVCHD is a new format (standard) for high definition video cameras that can be used to record and play high-resolution HD images.

BD-J

Some BD-Video discs contain Java applications, and these applications are called BD-J. You can enjoy various interactive features in addition to playing normal video.

BD-Live

This is a BD-Video (BD-ROM Profile 2) that supports the new functions such as Internet connection, etc. in addition to the BONUSVIEW function.

Bitstream

This is the digital form of multi-channel audio data (e.g., 5.1 channel) before it is decoded into its various channels.

BONUSVIEW (Final Standard Profile)

This is a BD-Video (BD-ROM Profile 1 version 1.1) that supports the new functions such as Picture-in-picture and Secondary Audio, etc.

Deep Colour

This unit incorporates HDMI™ (V.1.3a with Deep Colour) technology that can reproduce greater color gradation (4096 steps) when connected to a compatible TV.

You can enjoy exceptionally rich, natural-looking colors, with smooth, detailed gradation and minimal color banding. [A lower color gradation (256 steps), without Deep Colour, will be reproduced if connected to a TV which does not support Deep Colour.

The unit will automatically set appropriate output to suit the connected TV.]

DivX

DivX is a popular media technology created by DivX, Inc. DivX media files contain highly compressed video with high visual quality that maintains a relatively small file size.

DNS Server

A server which acts like a telephone directory and translates Internet domain names into IP addresses.

Dolby Digital

This is a method of coding digital signals developed by Dolby Laboratories. Apart from stereo (2-channel) audio, these signals can also be multi-channel audio.

Dolby Digital Plus

Multi-channel audio and higher audio quality is made possible using Dolby Digital Plus. BD-Video supports up to 7.1 channel output.

Dolby TrueHD

Dolby TrueHD is a very high quality audio format that reproduces the studio master audio. BD-Video supports up to 7.1 channel output.

Down-mixing

This is the process of remixing the multi-channel audio found on some discs into fewer channels.

DTS (Digital Theater Systems)

This surround system is used in many movie theaters. There is good separation between the channels, so realistic sound effects are possible.

DTS-HD

DTS-HD is a high-quality, sophisticated audio format used in movie theaters. Previous DTS Digital Surround-compatible equipment can play DTS-HD as DTS Digital Surround audio. BD-Video supports up to 7.1 channel output.

DTS-HD High Resolution Audio

This is a signal format achieved by improving the previous DTS, DTS-ES and DTS 96/24 formats. It is compatible with sampling frequency 96 kHz/48 kHz. BD-Video supports up to 7.1 channel output.

DTS-HD Master Audio

This is a lossless audio format and compatible with 96 kHz/7.1ch or less. In addition, faithful reproduction of the master audio is enabled using lossless audio encoding technology. BD-Video supports up to 7.1 channel output.

Dynamic range

Dynamic range is the difference between the lowest level of sound that can be heard above the noise of the equipment and the highest level of sound before distortion occurs.

Dynamic range compression means reducing the gap between the loudest and softest sounds. This means you can listen at low volumes but still hear dialog clearly.

Film and video

DVD-Video are recorded using either film or video. This unit can determine which type has been used, then uses the most suitable method of progressive output.

Film: Recorded at 25 frames per second (PAL discs) or 24 frames per second (NTSC discs). (NTSC discs recorded at 30 frames per second as well.)

Generally appropriate for motion picture films.

Video: Recorded at 25 frames/50 fields per second (PAL discs) or 30 frames/60 fields per second (NTSC discs). Generally appropriate for TV drama programs or animation.

Folder

This is a place on the disc, USB device or SD card where groups of data are stored together. Additional folders can be created within folders, and you can make detailed classifications depending on the folder structure. (⇒ 35)

Frames and fields

Frames refer to the single images that constitute the video you see on your television. Each frame consists of two fields.

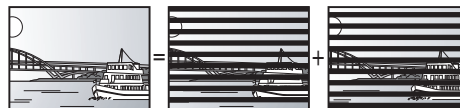

Frame

Field

Field

- A frame still shows two fields, so there may be some blurring, but picture quality is generally better.
- A field still shows less picture information so it may be rougher, but there is no blurring.

Gateway

IP address of the electronic device providing Internet access. Usually called a router IP address. (e.g., 192.168.0.1)

HDMI (High-Definition Multimedia Interface)

HDMI is a digital interface for consumer electronic products. Unlike conventional connections, it transmits uncompressed digital video and audio signals on a single cable.

Hub

Used for connecting more than one device to the network.

IP address

A set of numbers which distinguish each device on the network when, for example, connected to the Internet. When using a PC in a LAN to access a PC or device that is not included in the LAN, the IP address is called the local IP address. (e.g., 192.168.0.10)

JPEG (Joint Photographic Experts Group)

This is a system used for compressing/decoding color still pictures. If you select JPEG as the storage system on digital cameras, etc., the data will be compressed to 1/10–1/100 of its original size. The benefit of JPEG is less deterioration in picture quality considering the degree of compression.

LAN (Local Area Network)

A group of linked devices in a company, school or home. Indicates the boundaries of a particular network.

Local storage

This storage area is used as a destination for sub contents for playing BD-Live on BD-Video.

LPCM (Linear PCM)

These are a kind of PCM format.

These are uncompressed digital signals, similar to those found on CDs.

MPEG2 (Moving Picture Experts Group)

A standard for efficiently compressing and expanding colour video. MPEG2 is a compression standard used for DVD and satellite based digital broadcasting.

MP3 (MPEG Audio Layer 3)

An audio compression method that compresses audio to approximately one tenth of its size without any significant loss of audio quality.

P4HD (Pixel Precision Progressive Processing for HD)

This is a processor which makes use of an exclusive Panasonic algorithm. Various processing is supported, including a high-level conversion of the TV scanning format from interlace to progressive and a high-level conversion of standard resolution (480i or 576i) video signal to a 1080 High Definition video signal. Consequently, this unit is able to provide video of optimal resolution to the connected TV.

Pan&Scan/Letterbox

In general, DVD-Video are produced with the intention that they be viewed on a widescreen television (16:9 aspect ratio), so images often don't fit regular (4:3 aspect ratio) televisions. Two styles of picture, "Pan & Scan" and "Letterbox", deal with this problem.

Pan&Scan: The sides are cut off so the picture fills the screen.



Letterbox: Black bands appear at the top and bottom of the picture so the picture itself appears in an aspect ratio of 16:9.



PCM (Pulse Code Modulation)

This is one format for converting analog audio into digital audio, enabling you to enjoy digital audio with no hassle.

Picture-in-picture

This is a function of BD-Video that plays the primary video and secondary video simultaneously. For instance, the function is capable of playing the original movie as the primary video while playing video commentary from the film director on a small screen as a secondary video.

Progressive/Interlace

The PAL video signal standard has 625 (or 576) interlaced (i) scan lines, whereas progressive scanning, called 625p (or 576p), uses twice the number of scan lines. For the NTSC standard, these are called 525i (or 480i) and 525p (or 480p) respectively. Using progressive output, you can enjoy the high-resolution video recorded on media such as DVD-Video. Your television must be compatible to enjoy progressive video. Panasonic televisions with 625 (576)/50i · 50p, 525 (480)/60i · 60p input terminals are progressive compatible.

Router

Distinguishes the IP address assigned to each device, such as the PC, and relays the flow of data within the network.

Sampling frequency

Sampling is the process of converting the heights of sound wave (analog signal) samples taken at set periods into digits (digital encoding). Sampling frequency is the number of samples taken per second, so larger numbers mean more faithful reproduction of the original sound.

Subnet mask

Enables efficient network use. A set of numbers which identify which part of the IP address allocated to every device connected to the router is the network portion.

USB (Universal Serial Bus)

An interface specification to connect peripherals. Playback of MP3, JPEG, or DivX recorded to a USB memory by PC or other equipment, or JPEG in the Panasonic digital camera or similar connected via USB connection cable is possible with this unit.

VIERA CAST

An information service unique to Panasonic where specific Web sites can be viewed on this unit by connecting to the Internet without using a PC.

x.v.Colour™

x.v.Colour™ is a name for devices that are compatible with the xvYCC format, an international standard for expanded color in motion pictures, and that follow the rules for signal transmission. You can enjoy vivid colors of wider color ranges for a more realistic picture when connected to a TV that supports the x.v.Colour™ with HDMI cable.

1080i (1125i)

In one high definition image, 1080 (1125) alternating scan lines pass to create an interlaced image. Because 1080i (1125i) more than doubles current television broadcasts of 480i, the detail is much clearer and creates a more realistic and rich image.

1080p (1125p)

In one high definition image, 1080 (1125) scan lines pass at the same time to create a progressive image. Since progressive video does not alternate scan lines like interlace, there is a minimal amount of screen flicker.

24p

This is a progressive image recorded at a rate of 24 frames per second.

720p (750p)

In one high definition image, 720 (750) scan lines pass at the same time to create a progressive image. Since progressive video does not alternate scan lines like interlace, there is a minimal amount of screen flicker.

Specifications

Signal system: PAL/NTSC

Operating temperature range: +5 to +35 °C

Operating humidity range: 10 to 80 % RH (no condensation)

Playable disc:

BD-Video

BD-ROM: Version 2

BD-RE: Version 3 (Single Layer, Dual Layer), JPEG*6

BD-R: Version 2 (Single Layer, Dual Layer)

DVD-RAM:

DVD Video Recording format, AVCHD format*8,

JPEG*4

DVD-R/DVD-R DL:

DVD-Video format*1, DVD Video Recording format*1,

AVCHD format*1,8, DivX*7, JPEG*4, MP3

DVD-RW: DVD-Video format*1, DVD Video Recording format*1,

AVCHD format*1,8

+R/+RW/+R DL:

Video*1, AVCHD format*1,8

DVD-VIDEO:

DVD-Video format

CD-Audio:CD-DA

CD-R/CD-RW:CD-DA, JPEG*5, MP3, DivX*7

SD card:

SD Memory Card*2 formatted FAT12, FAT16, FAT32*3:

JPEG*4, AVCHD format*8, MPEG-2

USB device:

USB Standard:USB 2.0 High Speed

MP3, JPEG*4, DivX*7

Format:

FAT12, FAT16, FAT32

Video output:

Output level: 1.0 Vp-p (75 Ω)

Output connector: Pin jack (1 system)

Component video output:

(1080i/720p/480p/480i: 60 Hz)

(1080i/720p/576p/576i: 50 Hz)

Y output level: 1.0 Vp-p (75 Ω)

P_B output level: 0.7 Vp-p (75 Ω)

P_R output level: 0.7 Vp-p (75 Ω)

Output connector: Pin jack (Y: green, P_B: blue, P_R: red)

(1 system)

Audio output:

Output level: 2 Vrms (1 kHz, 0 dB)

Output connector: Pin jack

Number of connectors:

BD80: 7.1 channel discrete output: 1 system
(2 channel + 5.1 channel discrete output)

BD60: 2 channel: 1 system

Audio performance:

Frequency response:

• DVD (linear audio): 4 Hz to 22 kHz (48 kHz sampling)

4 Hz to 44 kHz (96 kHz sampling)

• CD-Audio: 4 Hz to 20 kHz

S/N ratio: 115 dB

Dynamic range: 100 dB

Total harmonic distortion: 0.003 %

Digital audio output:

Optical digital output:

Optical terminal

Coaxial digital output **BD80**:

Pin jack

HDMI AV output

Output format:

480p (525p)/576p (625p)/720p (750p)/1080i (1125i)/

1080p (1125p)

Output connector:

Type A (19 pin)

HDMI™ (V.1.3a with Deep Colour, x.v.Colour™, High Bit rate Audio)

• This unit supports "HDAVI Control 4" function.

SD card slot:

Connector:

1 system

USB slot:

Connector:

1 system

Ethernet:

10BASE-T/100BASE-TX:

1 system

Optical pick-up:

System with 2 lenses

Wave length: 790 nm (CDs)/650 nm (DVDs)/405 nm (BDs)

LASER Specification

Class 1 LASER Product:

Wave length: 790 nm (CDs)/650 nm (DVDs)/405 nm (BDs)

Laser power:

No hazardous radiation is emitted with the safety

protection

NORSK

Bølgelengde:

790 nm (CD)/650 nm (DVD)/405 nm (BD)

Laserstyrke:

Ingen farlig stråling sendes ut

Power supply:

AC 220 to 240 V, 50 Hz

Power consumption:

BD80: Approx. 24 W

BD60: Approx. 22 W

Power consumption in standby mode:

BD80

Quick Start: Off

less than 0.5 W

Quick Start: On

6 W

BD60

Quick Start: Off

less than 0.5 W

Quick Start: On

5 W

Dimensions (W×D×H)

BD80:

Excluding the projecting parts:

430 mm×242 mm×55 mm

Including the projecting parts:

430 mm×249 mm×55 mm

BD60:

Excluding the projecting parts:

430 mm×242 mm×49 mm

Including the projecting parts:

430 mm×249 mm×49 mm

Mass:

Approx. 2.6 kg

Note

Specifications are subject to change without notice.

*1 Finalizing is necessary.

*2 Includes SDHC card

Includes miniSD Cards (need a miniSD Adaptor)

Includes microSD Cards (need a microSD Adaptor)

*3 Does not support long file name

*4 The total combined maximum number of recognizable picture

contents and folders: 3000 picture contents and 300 folders.

*5 The total combined maximum number of recognizable picture

contents and folders: 999 picture contents and 99 folders.

*6 The total combined maximum number of recognizable picture

contents and folders: 9999 picture contents and 300 folders.

*7 The total combined maximum number of recognizable file

contents and folders: 200 file contents and 300 folders.

*8 AVCHD format V1.0

• Useable capacity will be less. (SD Card)

Language code list Enter the code with the numbered buttons.

Abkhazian: 6566	Catalan: 6765	Gujarati: 7185	Lingala: 7678	Rhaeto-Romance: 8277	Tamil: 8465
Afar: 6565	Chinese: 9072	Hausa: 7265	Lithuanian: 7684	Romanian: 8279	Tatar: 8484
Afrikaans: 6570	Corsican: 6779	Hebrew: 7387	Macedonian: 7775	Russian: 8285	Telugu: 8469
Albanian: 8381	Croatian: 7282	Hindi: 7273	Malagasy: 7771	Samoan: 8377	Thai: 8472
Amharic: 6577	Czech: 6783	Hungarian: 7285	Malay: 7783	Sanskrit: 8365	Tibetan: 6679
Arabic: 6582	Danish: 6865	Icelandic: 7383	Malayalam: 7776	Scots Gaelic: 7168	Tigrinya: 8473
Armenian: 7289	Dutch: 7876	Indonesian: 7378	Maltese: 7784	Serbian: 8382	Tonga: 8479
Assamese: 6583	English: 6978	Interlingua: 7365	Maori: 7773	Serbo-Croatian: 8372	Turkish: 8482
Aymara: 6589	Esperanto: 6979	Irish: 7165	Marathi: 7782	Shona: 8378	Turkmen: 8475
Azerbaijani: 6590	Estonian: 6984	Italian: 7384	Moldavian: 7779	Sindhi: 8368	Twi: 8487
Bashkir: 6665	Faroese: 7079	Japanese: 7465	Mongolian: 7778	Singhalese: 8373	Ukrainian: 8575
Basque: 6985	Fiji: 7074	Javanese: 7487	Nauru: 7865	Slovak: 8375	Urdu: 8582
Bengali; Bangla: 6678	Finnish: 7073	Kannada: 7578	Nepali: 7869	Slovenian: 8376	Uzbek: 8590
Bhutani: 6890	French: 7082	Kashmiri: 7583	Norwegian: 7879	Somali: 8379	Vietnamese: 8673
Bihari: 6672	Frisian: 7089	Kazakh: 7575	Oriya: 7982	Spanish: 8083	Volapük: 8679
Breton: 6682	Galician: 7176	Kirghiz: 7589	Pashto, Pushto: 8083	Swahili: 8387	Welsh: 8789
Bulgarian: 6671	Georgian: 7565	Korean: 7579	Persian: 7065	Sundanese: 8385	Xhosa: 8872
Burmese: 7789	German: 6869	Kurdish: 7585	Polish: 8076	Swedish: 8386	Yiddish: 7473
Burmese: 7789	Greek: 6976	Laotian: 7679	Portuguese: 8084	Tagalog: 8476	Yoruba: 8979
Byelorussian: 6669	Greenlandic: 7576	Latin: 7665	Punjabi: 8065	Tajik: 8471	Zulu: 9085
Cambodian: 7577	Guarani: 7178	Latvian, Lettish: 7686	Quechua: 8185		

Java and all Java-based trademarks and logos are trademarks or registered trademarks of Sun Microsystems, Inc. in the United States and other countries.	
Manufactured under license from Dolby Laboratories. Dolby and the double-D symbol are trademarks of Dolby Laboratories.	
Manufactured under license under U.S. Patent #'s: 5,451,942; 5,956,674; 5,974,380; 5,978,762; 6,226,616; 6,487,535; 7,392,195; 7,272,567; 7,333,929; 7,212,872 & other U.S. and worldwide patents issued & pending. DTS is a registered trademark and the DTS logos, Symbol, DTS-HD and DTS-HD Master Audio Essential are trademarks of DTS, Inc. © 1996-2008 DTS, Inc. All Rights Reserved.	
This product incorporates copyright protection technology that is protected by U.S. patents and other intellectual property rights. Use of this copyright protection technology must be authorized by Macrovision, and is intended for home and other limited viewing uses only unless otherwise authorized by Macrovision. Reverse engineering or disassembly is prohibited.	
HDMI, the HDMI logo and High-Definition Multimedia Interface are trademarks or registered trademarks of HDMI Licensing LLC.	
This product is licensed under the AVC patent portfolio license and VC-1 patent portfolio license for the personal and non-commercial use of a consumer to (i) encode video in compliance with the AVC Standard and VC-1 Standard ("AVC/VC-1 Video") and/or (ii) decode AVC/VC-1 Video that was encoded by a consumer engaged in a personal and non-commercial activity and/or was obtained from a video provider licensed to provide AVC/VC-1 Video. No license is granted or shall be implied for any other use. Additional information may be obtained from MPEG LA, LLC. See http://www.mpegla.com .	
HDAVI Control™ is a trademark of Panasonic Corporation.	
"AVCHD" and the "AVCHD" logo are trademarks of Panasonic Corporation and Sony Corporation.	
SDHC Logo is a trademark.	
Portions of this product are protected under copyright law and are provided under license by ARIS/SOLANA/4C.	
x.v.Colour™ is a trademark.	
VIERA CAST™ is a trademark of Panasonic Corporation.	
Plays DivX® video DivX® is a registered trademark of DivX, Inc., and is used under license.	
"Blu-ray Disc" is trademark.	
"BD-LIVE" logo is trademark of Blu-ray Disc Association.	
"BONUSVIEW" is trademark of Blu-ray Disc Association.	
YouTube and Picasa are trademarks of Google, Inc.	

SUOMI

VAROITUS!

LAITTEEN KÄYTTÄMINEN MUULLA KUIN TÄSSÄ KÄYTTÖOHJEESSA MAINITULLA TAVALLA SAATTAÄ ALTISTAA KÄYTTÄJÄÄ TURVALLISUUSLUOKAN 1 YLITÄVÄLLE NÄKYMÄTTÖMÄLLE LASERSÄTEILYLLE.

VAROITUS:

VÄHENNÄ TULIPALON, SÄHKÖISKUN TAI LAITTEISTON VAHINGOITTUMISEN VAARAA

- TÄTÄ LAITETTA EI SAA ALTISTAA SATEELLE, KOSTEUELLE, ROISKEILLE TAI TIPPUVILLE NESTEILLE. LAITTEEN PÄÄLLE EI SAA MYÖSKÄÄN ASETTAA MITÄÄN NESTEELLÄ TÄYTETTYÄ ESINETTÄ, KUTEN MALJAKKOA.
- KÄYTÄ VAIN SUOSITELTUJA LISÄVARUSTEITA.
- ÄLÄ IRROTA KANTTA (TAI TAUSTAA). SISÄLLÄ EI OLE KÄYTTÄJÄÄ HUOLLETTAVISSA OLEVIA OSIA. HUOLLON SAA SUORITTAÄ VAIN AMMATITAITOINEN HENKILÖKUNTA.

VAROITUS!

- ÄLÄ ASENNÄ TAI LAITA TÄTÄ LAITETTA KABINETTITYYPPISEEN KIRJAKAAPPIIN TAI MUUHUN SULJETTUUN TILAAÄ, JOTTA TUULETUS ONNISTUISI. VARMISTA, ETTÄ VERHO TAI MIKÄÄN MUU MATERIAALI EI HUONONNA TUULETUSTA, JOTTA VÄLTETTÄISIN YLIKUUMENEMISESTÄ JOHTUVA SÄHKÖISKU- TAI TULIPALOVAARA.
- ÄLÄ PEITÄ LAITTEEN TUULETUSAUKKOJA SANOMALEHDellä, PÖYTÄLIINALLA, VERHOLLA TAI MUULLA VASTAAVALLA ESINEELLÄ.
- ÄLÄ ASETÄ PALAVAA KYNTTILÄÄ TAI MUUTA AVOTULEN LÄHDETTÄ LAITTEEN PÄÄLLE.
- HÄVITÄ PARISTOT LUONTOA VAHINGOITTAMATTOMALLA TAVALLA.

Pistorasia tulee asentaa laitteen lähelle helpoppääsyiseen paikkaan. Verkkojohdon pistokkeen on oltava aina helposti käytettävissä. Tämä laite voidaan kytkeä kokonaan irti verkkojohdon irrottamalla verkkojohdon pistoke pistorasiasta.

TÄMÄ LAITE ON TARKOITETTU KÄYTETTÄVÄKSI LEUDOSSA ILMASTOSSA.

NORSK

ADVARSEL!

DETTE PRODUKTET ANVENDER EN LASER. BETJENING AV KONTROLLER, JUSTERINGER ELLER ANDRE INNGREP ENN DE SOM ER BESKREVET I DENNE BRUKSANVISNING, KAN FØRE TIL FARLIG BESTRÅLING. DEKSLER MÅ IKKE ÅPNES, OG FORSØK ALDRI Å REPARERE APPARATET PÅ EGENHÅND. ALT SERVICE OG REPARASJONSARBEID MÅ UTFØRES AV KVALIFISERT PERSONELL.

ADVARSEL:

FØLG NEDENSTÅENDE INSTRUKSER FOR Å REDUSERE RISIKOEN FOR BRANN, ELEKTRISK STØT OG SKADE PÅ PRODUKTET:

- DETTE APPARATET MÅ IKKE UTSETTES FOR REGN, FUKTIGHET, DRYPP ELLER SPRUT, OG INGEN VÆSKEFYLTE GJENSTANDER, SOM F.EKS. VASER, MÅ Plasseres PÅ APPARATET.
- BRUK KUN ANBEFALT TILBEHØR.
- IKKE FJERN DEKSELET (ELLER BAKSIDEN); APPARATET INNEHOLDER INGEN DELER SOM KAN SKIFTES ELLER REPARERES AV BRUKEREN. OVERLAT TIL KVALIFISERTE SERVICETEKNIKERE Å UTFØRE SERVICE.

ADVARSEL!

- APPARATET MÅ IKKE Plasseres I EN BOKHYLLE, ET INNEBYGGET KABINETT ELLER ET ANNET LUKKET STED HVOR VENTILASJONSFORHOLDENE ER UTILSTREKKELIGE. SØRG FOR AT GARDINER ELLER LIGNENDE IKKE FORVERRER VENTILASJONSFORHOLDENE, SÅ RISIKO FOR ELEKTRISK SJOEK ELLER BRANN FORÅRSAKET AV OVERHETING UNNGÅS.
- APPARATETS VENTILASJONSÅPNINGER MÅ IKKE DEKKES TIL MED AVISER, BORDDUKER, GARDINER OG LIGNENDE.
- Plasser IKKE ÅPEN ILD, SLIK SOM LEVENDE LYS, OPPÅ APPARATET.
- BRUKTE BATTERIER MÅ KASSERES UTEN FARE FOR MILJØET.

Strømuttaket må befinne seg i nærheten av utstyret og være lett tilgjengelig.

Støpslet på strømkabelen må være klart til bruk. Når dette apparatet skal kobles helt fra strømmettet (AC), må støpslet på strømkabelen trekkes ut av stikkontakten.

DETTE APPARATET ER BEREKNET TIL BRUK UNDER MODERATE KLIMAFORHOLD.

Index

A	Angle	26
	Audio	
	Attribute	26
	Changing audio	18
	Channel	26
	Language	26, 29
	AVCHD	42
B	BD-J	42
	BD-Live	19, 42
	BD-Video Ratings	29
	BONUSVIEW (Final Standard Profile)	19, 42
C	Chapter	18
	Cleaning	
	Disc	3
	Lens	3
	Main unit	3
	Connection	
	Amplifier/Receiver	9, 10
	HDMI	8, 9
D	Deep Colour	42
	Default Settings	32
	Dialog Enhancer	27
	Direct Navigator	16
	DivX	24, 34, 42
	DNS Server	14, 42
	Dolby Digital	20, 30, 42
	Dolby Digital Plus	20, 30, 42
	Dolby TrueHD	20, 30, 42
	DTS	20, 30, 42
	DTS-HD	20, 30, 42
F	Finalize	6
	Firmware	13
	Format	19
H	HDMI	8, 9, 42
	High Clarity Sound	27, 30
I	IP address	14, 42
J	JPEG	22, 34, 43
L	LAN	13, 43
	Language	
	Audio	26, 29
	Code list	45
	Menu	29
	On-screen	30
	Soundtrack	26
	Subtitle	26, 29
	Local storage	43
	LPCM	43

M	Maintenance	3
	Menu	
	On-screen	26
	Pop-up	16
	Setup	29
	MPEG2	43
	MP3	21, 34, 43
N	Noise reduction (NR)	
	Integrated NR	27
	3D NR	27
O	On-screen	
	Language	30
	Menu	26
	Status messages	17
P	PCM Down Conversion	30
	Picture-in-picture	19
	Playback Information Window	27
	Playlist	25
	Pop-up Menu	16
	Progressive	27, 43
	Properties	
	Chapter	18
	Still picture	23
	Proxy Server	15
	P4HD	43
Q	Quick Start	32
R	Ratings level	29
	Re-master	18, 27
	Remote control code	41
	Repeat play	27
	Resume play function	17
S	SD card	7, 19
	Setup menu	29
	Slideshow	23
	Soundtrack	26
	Status Message	17
	Still pictures	22
	Subtitle	26
T	TV System	31
U	USB device	7
V	V. Surround	27
	VIERA CAST™	25
	VIERA Link “HDAVI Control™”	28
X	x.v.Colour™	43
	24p	27, 31

CAUTION	VISIBLE AND INVISIBLE LASER RADIATION WHEN OPEN. DO NOT STARE INTO BEAM. FDA 21 CFR/Class II (IIR)
CAUTION	CLASS 1M VISIBLE AND INVISIBLE LASER RADIATION WHEN OPEN. DO NOT VIEW DIRECTLY WITH OPTICAL INSTRUMENTS. IEC 60825-1, #2/CLASS 1M
ATTENTION	RAYONNEMENT LASER VISIBLE ET INVISIBLE, CLASSE 1M. EN CAS D'OUVERTURE, NE PAS REGARDER DIRECTEMENT À L'AIDE D'INSTRUMENTS D'OPTIQUE.
FORSIGTIG	SYNLIG OG USYNLIG LASERSTRÅLING KLASSE 1M. NÅR LÅGET ER ÅBENT, UNDGÅ AT SE LIGE PÅ MED OPTISKE INSTRUMENTER.
VARO	AVATTIENNA OLET ALTIIINA LUOKAN 1M NÄKYVÄÄ JA NÄKYMÄTÖNTÄ LASERSÄTELYÄ. ÄLÄ KATSO OPTISELLA LAITTEELLA SUORAAN SÄTEESEEN.
WARNING	KLASS 1M SYNLIG OCH OSYNLIG LASERSTRÅLNING NÅR DENNA DEL ÄR ÖPPNAD. BETRÄKTA EJ STRÅLEN DIREKT GENOM OPTISKT INSTRUMENT.
VORSICHT	SICHTBARE UND UNSICHTBARE LASERSTRÄHLUNG KLASSE 1M. WENN ABDECKUNG GEÖFFNET, NICHT DIREKT MIT OPTISCHEN INSTRUMENTEN BETRACHTEN.
注意	打开时有可见及不可见激光辐射。避免光眼照射。
注意	ここを開くと可視及び不可視レーザー光が出ます。ヒームを見たり、離れたらしないでください。 VOL11770

(Inside of product)
(Tuotteen sisällä)
(Produktets innsida)



LUOKAN 1 LASERLAITE
KLASS 1 LASER APPARAT

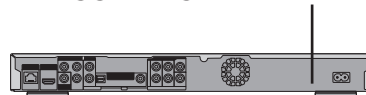

(Back of product)



Environment friendly printed on chlorine free bleached paper.

Panasonic Corporation

Web Site: <http://panasonic.net>

Pursuant to at the directive 2004/108/EC, article 9(2)
Panasonic Testing Centre
Panasonic Marketing Europe GmbH
Winsbergring 15, 22525 Hamburg, Germany

En

RQT9401-2B
F0109YA2029