

TABLE OF CONTENTS

SPECIAL NOTES ON LCD MONITORS.....	1
INFORMATION FOR YOUR SAFETY AND COMFORT	2
UNPACKING	5
ATTACHING / REMOVING THE BASE.....	6
SCREEN POSITION ADJUSTMENT	7
CONNECTING THE POWER CORD	9
SAFETY PRECAUTION.....	9
CLEANING YOUR MONITOR.....	9
POWER SAVING	10
DDC	10
CONNECTOR PIN ASSIGNMENT.....	11
STANDARD TIMING TABLE	13
INSTALLATION	14
USER CONTROLS.....	15
HOW TO ADJUST A SETTING	16
TROUBLESHOOTING	20

SPECIAL NOTES ON LCD MONITORS

The following symptoms are normal with LCD monitor and do not indicate a problem.

NOTES

- Due to the nature of the fluorescent light, the screen may flicker during initial use. Turn off the Power Switch and then turn it on again to make sure the flicker disappears.
- You may find slightly uneven brightness on the screen depending on the desktop pattern you use.
- The LCD screen has effective pixels of 99.99% or more. It may include blemishes of 0.01% or less such as a missing pixel or a pixel lit all of the time.
- Due to the nature of the LCD screen, an afterimage of the previous screen may remain after switching the image, when the same image is displayed for hours. In this case, the screen is recovered slowly by changing the image or turning off the Power Switch for hours.

INFORMATION FOR YOUR SAFETY AND COMFORT

Safety instructions

Read these instructions carefully. Keep this document for future reference. Follow all warnings and instructions marked on the product.

CAUTION for accessibility

Be sure that the power outlet you plug the power cord into is easily accessible and located as close to the equipment operator as possible. When you need to disconnect power to the equipment, be sure to unplug the power cord from the electrical outlet.

Warnings

- Do not use this product near water.
- Do not place this product on an unstable cart, stand or table. If the product falls, it could be seriously damaged.
- Slots and openings are provided for ventilation to ensure reliable operation of the product and to protect it from overheating. These openings must not be blocked or covered. The openings should never be blocked by placing the product on a bed, sofa, rug or other similar surface. This product should never be placed near or over a radiator or heat register, or in a built-in installation unless proper ventilation is provided.
- Never push objects of any kind into this product through cabinet slots as they may touch dangerous voltage points or short-out parts that could result in a fire or electric shock. Never spill liquid of any kind onto or into the product.
- To avoid damage of internal components and to prevent battery leakage, do not place the product on a vibrating surface.
- Never use it under sporting, exercising, or any vibrating environment which will probably cause unexpected short current or damage rotor devices, HDD, Optical drive, and even exposure risk from lithium battery pack.

Safe listening

Follow these instructions, suggested by hearing experts, to protect your hearing.

- Gradually increase the volume until you can hear it clearly and comfortably and without distortion.
- After setting the volume level, do not increase it after your ears adjust.
- Limit the amount of time listening to music at high volume.
- Avoid turning up the volume to block out noisy surroundings.
- Turn the volume down if you can't hear people speaking near you.

Product servicing

Do not attempt to service this product yourself, as opening or removing covers may expose you to dangerous voltage points or other risks. Refer all servicing to qualified service personnel.

Unplug this product from the wall outlet and refer servicing to qualified service personnel when:

- the power cord or plug is damaged, cut or frayed liquid was spilled into the product
- the product was exposed to rain or water
- the product has been dropped or the case has been damaged
- the product exhibits a distinct change in performance, indicating a need for service
- the product does not operate normally after following the operating instructions



Note: Adjust only those controls that are covered by the operating instructions, since improper adjustment of other controls may result in damage and will often require extensive work by a qualified technician to restore the product to normal condition.

LCD Pixel Statement

The LCD unit is produced with high-precision manufacturing techniques. Nevertheless, some pixels may occasionally misfire or appear as black or red dots. This has no effect on the recorded image and does not constitute a malfunction.

Tips and information for comfortable use

Computer users may complain of eyestrain and headaches after prolonged use. Users are also at risk of physical injury after long hours of working in front of a computer. Long work periods, bad posture, poor work habits, stress, inadequate working conditions, personal health and other factors greatly increase the risk of physical injury.

Incorrect computer usage may lead to carpal tunnel syndrome, tendonitis, tenosynovitis or other musculoskeletal disorders. The following symptoms may appear in the hands, wrists, arms, shoulders, neck or back:

- numbness, or a burning or tingling sensation
- aching, soreness or tenderness
- pain, swelling or throbbing
- stiffness or tightness
- coldness or weakness

If you have these symptoms, or any other recurring or persistent discomfort and/or pain related to computer use, consult a physician immediately and inform your company's health and safety department.

The following section provides tips for more comfortable computer use.

Finding your comfort zone

Find your comfort zone by adjusting the viewing angle of the monitor, using a footrest, or raising your sitting height to achieve maximum comfort. Observe the following tips:

- refrain from staying too long in one fixed posture
- avoid slouching forward and/or leaning backward
- stand up and walk around regularly to remove the strain on your leg muscles
- take short rests to relax your neck and shoulders
- avoid tensing your muscles or shrugging your shoulders
- install the external display, keyboard and mouse properly and within comfort able reach
- if you view your monitor more than your documents, place the display at the center of your desk to minimize neck strain

Taking care of your vision

Long viewing hours, wearing incorrect glasses or contact lenses, glare, excessive room lighting, poorly focused screens, very small typefaces and low-contrast displays could stress your eyes. The following sections provide suggestions on how to reduce eyestrain.

Eyes

- Rest your eyes frequently.
- Give your eyes regular breaks by looking away from the monitor and focusing on a distant point.
- Blink frequently to keep your eyes from drying out.

Display

- Keep your display clean.
- Keep your head at a higher level than the top edge of the display so your eyes point downward when looking at the middle of the display.
- Adjust the display brightness and/or contrast to a comfortable level for enhanced text readability and graphics clarity.
- Eliminate glare and reflections by:
 - ♦ placing your display in such a way that the side faces the window or any light source
 - ♦ minimizing room light by using drapes, shades or blinds
 - ♦ using a task light
 - ♦ changing the display's viewing angle
 - ♦ using a glare-reduction filter
 - ♦ using a display visor, such as a piece of cardboard extended from the display's top front edge
- Avoid adjusting your display to an awkward viewing angle.
- Avoid looking at bright light sources, such as open windows, for extended periods of time.

Developing good work habits

Develop the following work habits to make your computer use more relaxing and productive:

- Take short breaks regularly and often.
- Perform some stretching exercises.
- Breathe fresh air as often as possible.
- Exercise regularly and maintain a healthy body.



Warning! We do not recommend using the product on a couch or bed. If this is unavoidable, work for only short periods, take breaks regularly, and do some stretching exercises.



For more information and help in recycling, please visit the following websites: Worldwide:

<http://www.acer-group.com/public/Sustainability/sustainability01.htm>

<http://www.acer-group.com/public/Sustainability/sustainability04.htm>

UNPACKING

Please check the following items are present when you unpack the box, and save the packing materials in case you will need to ship or transport the monitor in future.

LCD Monitor

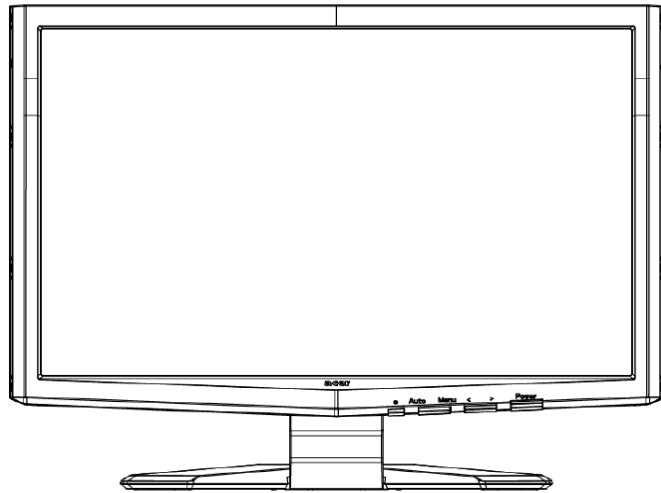

AC Power Cord

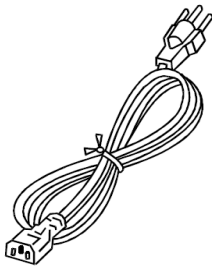

D-Sub Cable



DVI Cable

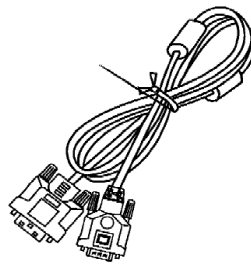

HDMI cable



USB cable



Audio cable

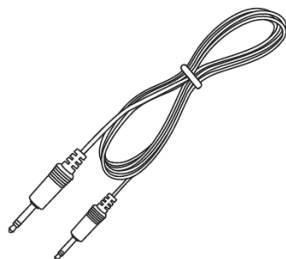

User Manual



Quick Start Guide



ATTACHING / REMOVING THE BASE

Install:

Align the base with the stand and push the base towards the top of the monitor, and then rotate the base clockwise. Tighten the screw clockwise.

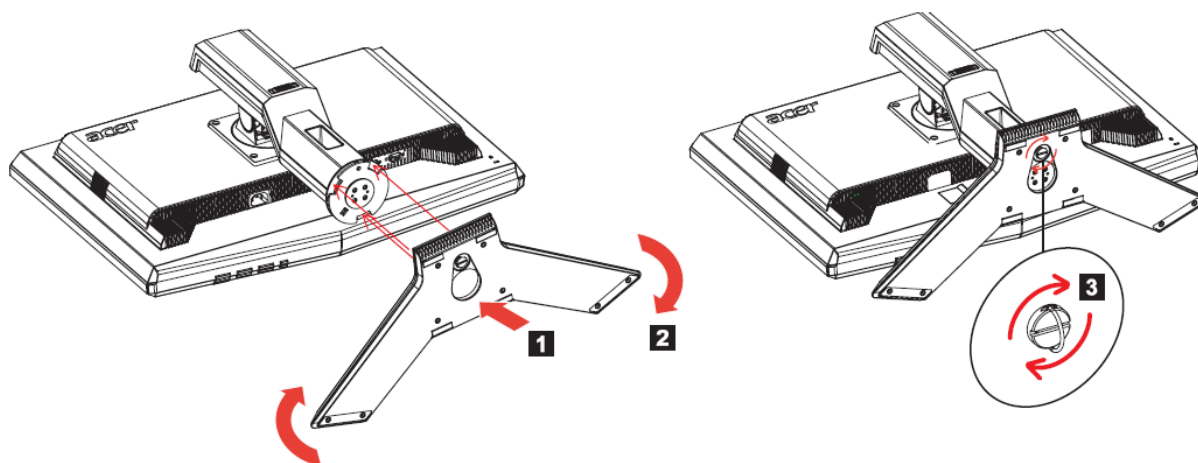

Remove:

Reverse the steps to remove the base.

SCREEN POSITION ADJUSTMENT

In order to optimize the best viewing position, you can adjust the height/tilt/swivel of the monitor.

• Height Adjustment

After pressing the top of the monitor, push the lock button towards right, then you can adjust the height of the monitor.

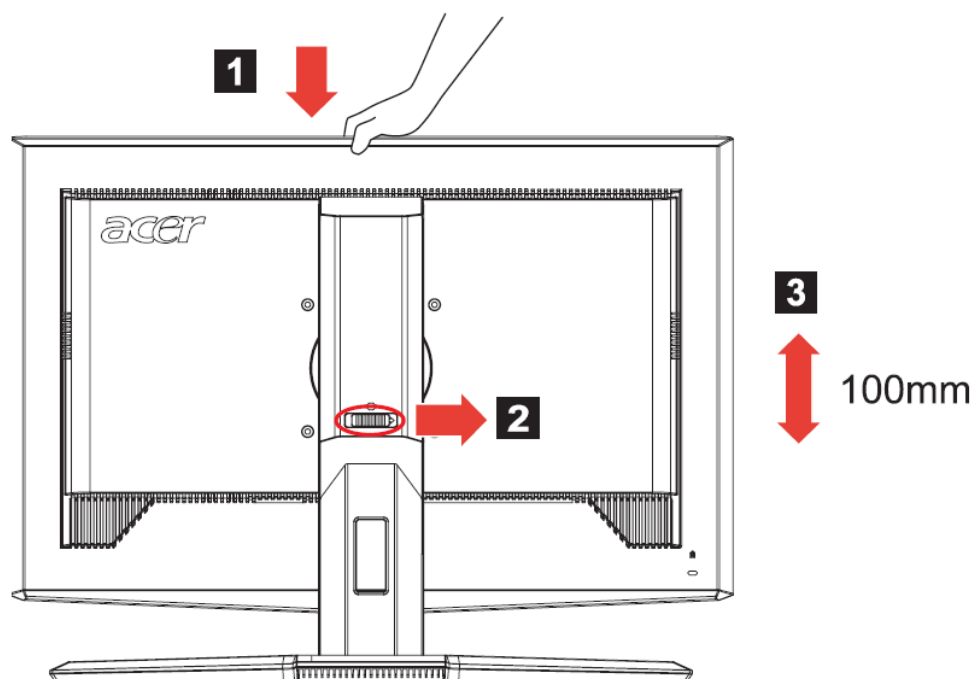

• Tilt

Please see the illustration below for an example of the tilt range.

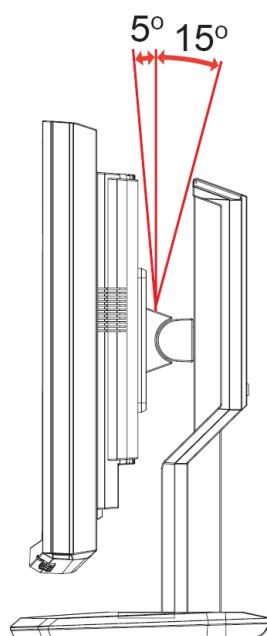

- **Swivel**

With the built-in pedestal, you can swivel the monitor for the most comfortable viewing angle.

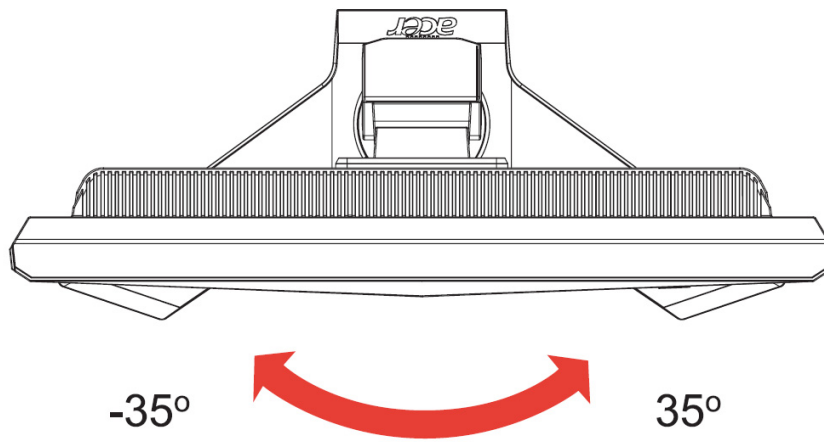

CONNECTING THE POWER CORD

- Check first to make sure that the power cord you use is the correct type required for your area.
- This monitor has a universal power supply that allows operation in either 100/120V AC or 220/240 V AC voltage areas. No user-adjustment is required.
- Plug one end of the power cord to the AC Inlet, plug another end to a proper AC outlet.
- For unit using at 120 V AC:
 - Use a UL Listed Cord Set, Type SVT wire and plug rated 10 A/125 V.
- For unit using at 220/240 V AC (outside of U.S.):
 - Use a Cord Set consisting of H05VV-F cord and plug rated 10 A, 250 V. The cord set should have the appropriate safety approvals for the country in which the equipment will be installed.

SAFETY PRECAUTION

- Avoid placing the monitor, or any other heavy object, on the power cord to avoid damage to the cable.
- Do not expose the monitor to rain, excessive moisture, or dust.
- Do not cover the ventilation slots or openings of the monitor. Always put the monitor in a place where there is adequate ventilation.
- Avoid placing the monitor against a bright background or where sunlight or other light sources may reflect on the face of the monitor. Place the monitor just below eye level.
- Handle with care when transporting the monitor.
- Refrain from giving shock or scratch to the screen, as screen is fragile.

CLEANING YOUR MONITOR

Please carefully follow the below guidelines when cleaning the monitor.

- Always unplug the monitor before cleaning.
- Use a soft cloth to wipe the screen and cabinet front and sides.

POWER SAVING

The monitor will be driven into Power Saving" mode by the control signal from the display controller, as indicated by the amber-color power LED.

State	LED Light
ON	Blue
Power Saving Mode	Amber

The power saving states will be kept until a control signal has been detected or the keyboard or mouse is activated. The recovery time from Active OFF state back to ON state is around 5 seconds.

DDC

To make your installation easier, the monitor is able to Plug and Play with your system if your system also supports DDC protocol. The DDC (Display Data Channel) is a communication protocol through which the monitor automatically informs the host system about its capabilities, for example, supported resolutions and corresponding timing. The monitor supports DDC2B standard.

CONNECTOR PIN ASSIGNMENT

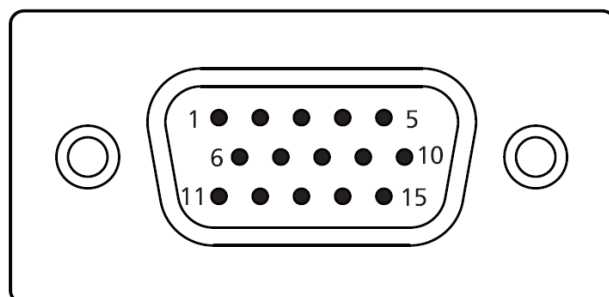

15-Pin Color Display Signal Cable

PIN NO.	DESCRIPTION	PIN NO.	DESCRIPTION
1.	Red	9.	+5V
2.	Green	10.	Logic Ground
3.	Blue	11.	Monitor Ground
4.	Monitor Ground	12.	DDC-Serial Data
5.	DDC-return	13.	H-Sync
6.	R-Ground	14.	V-Sync
7.	G-Ground	15.	DDC-Serial Clock
8.	B-Ground		

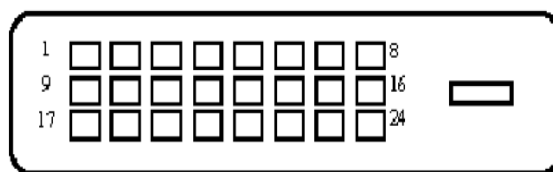

24-Pin Color Display Signal Cable

PIN NO.	DESCRIPTION	PIN NO.	DESCRIPTION
1.	TMDS Data2-	13.	TMDS Data3+
2.	TMDS Data2+	14.	+5V Power
3.	TMDS Data 2/4 Shield	15.	GND(return for +5V hsync.vsync)
4.	TMDS Data4-	16.	Hot Plug Detect
5.	TMDS Data4+	17.	TMDS Data0-
6.	DDC Clock	18.	TMDS Data0+
7.	DDC Data	19.	TMDS Data 0/5
8.	Analogue Vertical Sync	20.	TMDS Data5-
9.	TMDS Data1-	21.	TMDS Data5+
10.	TMDS Data1+	22.	TMDS Clock Shield
11.	TMDS Data 1/3 Shield	23.	TMDS Clock+
12.	TMDS Data3-	24.	DDC TMDS Clock-

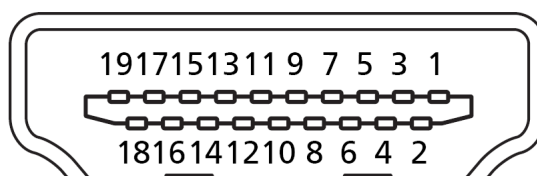

19-pin color display signal cable

PIN NO.	DESCRIPTION	PIN NO.	DESCRIPTION
1.	TMDS Data2+	2.	TMDS Data2 Shield
3.	TMDS Data2-	4.	TMDS Data1+
5.	TMDS Data1 Shield	6.	TMDS Data1-
7.	TMDS Data0+	8.	TMDS Data0 Shield
9.	TMDS Data0-	10.	TMDS Clock+
11.	TMDS Clock Shield	12.	TMDS Clock-
13.	CEC	14.	Reserved (N.C. on device)
15.	SCL	16.	SDA
17.	DDC/CEC Ground	18.	+5V Power
19.	Hot Plug Detect		

STANDARD TIMING TABLE

Mode	Resolution			
1	VGA	640 x 480	60	Hz
2	VGA	640 x 480	66.6	Hz
3	VESA	720 x 400	70	Hz
4	SVGA	800 x 600	56	Hz
5	SVGA	800 x 600	60	Hz
6	XGA	1024 x 768	60	Hz
7	XGA	1024 x 768	70	Hz
8	VESA	1152 x 864	75	Hz
9	WXGA	1280 x 800	60	Hz
10	SXGA	1280 x 1024	60	Hz
11	WXGA+	1440 x 900	60	Hz
12	UXGA	1920 x 1080	60	Hz

INSTALLATION

To install the monitor to your host system, please follow the steps as given below:

Steps

Make sure both the monitor and computer are powered-OFF.

- 1-1 Connect Video Cable
Connect the VGA video cable to the computer.
 - 1-2 Connect Digital Cable
Connect one end of the 24-pin DVI cable to the back of the monitor and connect the other end to the computer's port.
 - 1-3 Connect HDMI Cable
Connect the HDMI cable to the computer.
 - 1-4 Connect Audio Cable
Connect the Audio cable to the computer.
 - 1-5 Connect USB Cable
Connect the USB cable to the computer.
2. Connect power cord
Connect the power cord to the monitor, then to a properly grounded AC outlet.
 3. Power-ON Monitor and Computer
Power-ON the monitor first, then power-ON the computer.
This sequence is very important.
 4. If the monitor still does not function properly, please refer to the troubleshooting section to diagnose the problem.

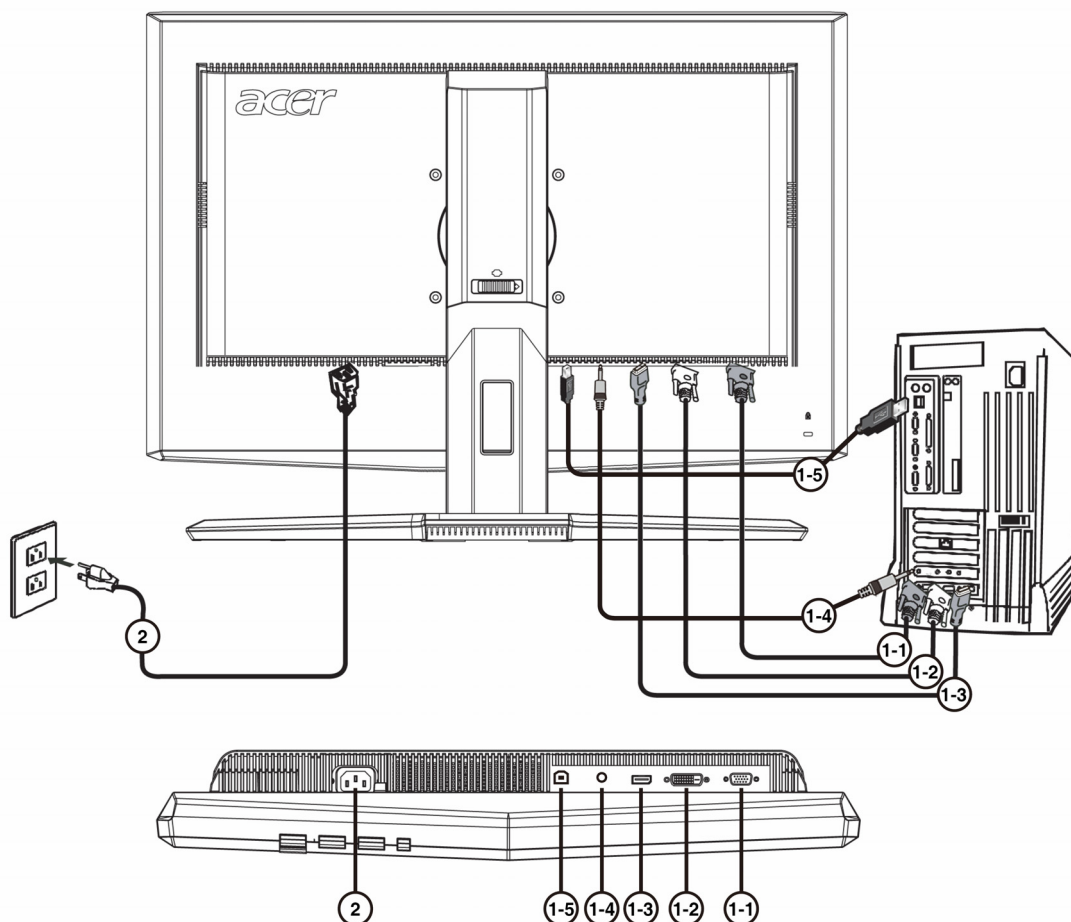

USER CONTROLS

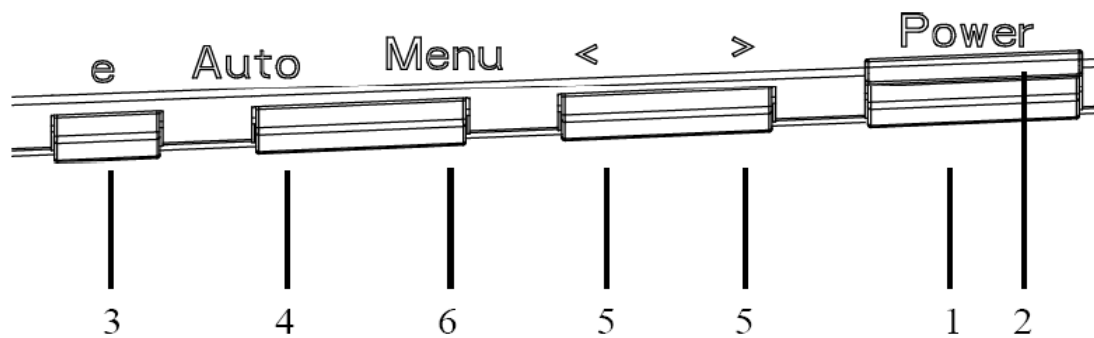

Front Panel Controls

1.Power Switch:

To turn ON or OFF the power.

2.Power LED:

Lights up to indicate the power is turned ON.

3. Empowering / Exit:

- 1) When OSD menu is in active status, this button will act as EXIT-KEY (EXIT OSD menu).
- 2) When OSD menu is in off status, press this button to select scenario mode.

4.Auto Adjust button / Exit:

- 1) When OSD menu is in active status, this button will act as EXIT-KEY (EXIT OSD menu).
- 2) When OSD menu is in off status, press this button for 2 seconds to activate the Auto Adjustment function. The Auto Adjustment function is used to set the HPos, VPos, Clock and Focus.

5.< / >

Press < or > to select the desired function. Press < or > to change the settings of the current function.

6.MENU / ENTER:

Activate OSD menu when OSD is OFF or activate/de-activate adjustment function when OSD is ON.

HOW TO ADJUST A SETTING

1. Press the MENU-button to activate the OSD window.
 2. Press < or > to select the desired function.
 3. Press the MENU-button to select the function that you want to adjust.
 4. Press < or > to change the settings of the current function.
 5. To exit and save, select the exit function. If you want to adjust any other function, repeat steps 2-4.
- P/X Series OSD behave
When user press "MENU" button on front bezel

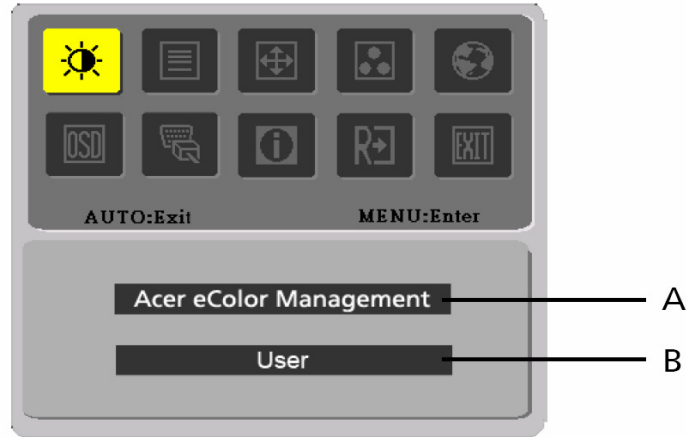

- A. Acer eColor Management
If selected to "Acer eColor Management" item, will appear the Acer eColor" OSD
- B. USER
If selected to "USER" item, will appear the Standard OSD



I. Only Analog Input Model







II. Only Dual Input Model







ADJUSTING THE PICTURE

















The descriptions for function control LEDs

A. Acer eColor Management

Main Menu icon	Sub Menu icon	Sub Menu item	Description
	N/A	User mode	User defined. Settings can be fine-tuned to suit any situation
	N/A	Text mode	Optimal balance of brightness and contrast prevent eyestrain. The most comfortable way to read onscreen text
	N/A	Standard mode	Default Setting. Reflects native display capability
	N/A	Graphic mode	Enhances colors and emphasize fine detail
	N/A	Movie mode	Displays scenes in clearest detail. Pictures and photographs appear in vibrant colors with sharp detail

B. USER.

Main Menu icon	Sub Menu icon	Sub Menu item	Description
		Contrast	Adjust the contrast between the foreground and background of the screen image
		Brightness	Adjust the background brightness of the screen image
		ACM	ACM (Adaptive Contrast Management)A CM ON/OFF Switch, default "OFF"
		Focus	Adjust picture Focus (available in analog mode only)
		Clock	Adjust picture Clock (available in analog mode only)

Main Menu icon	Sub Menu icon	Sub Menu item	Description
		H. Position	Adjust the horizontal position. (available in Analog mode only)
		V. Position	Adjust the vertical position. (available in Analog mode only)
	N/A	Warm	Set the color temperature to warm white.
	N/A	Cool	Set the color temperature to cool white.
		User /Red	Adjusts Red/Green/Blue intensity
		User /Green	
	User /Blue		
	N/A	English	Multi-language selection.
	N/A	繁體中文	
	N/A	Deutsch	
	N/A	Français	
	N/A	Español	
	N/A	Italiano	
	N/A	简体中文	
	N/A	日本語	
	N/A	Suomi	EMEA version OSD only
	N/A	Nederlands	
	N/A	Русский	
		H. Position	Adjust the horizontal position of the OSD.
		V. Position	Adjust the vertical position of the OSD.
		OSD Timeout	Adjust the OSD timeout.
	N/A	Input Source	Select input signal from D-Sub or DVI-D or HDMI
	N/A	DDC/CI	Turn ON/OFF DDC/CI support
	N/A	Information	Show the resolution, H/V frequency and input port of current input timing.
	N/A	Reset	Clear each old status of Auto-configuration and set the color temperature to Warm.
	N/A	Exit	Save user adjustment and OSD disappear.

Acer eColor Management OSD

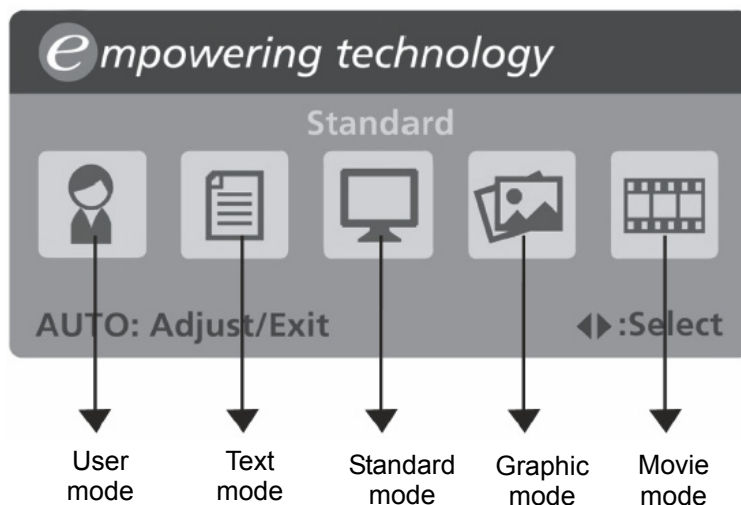

Operation instructions

Acer eColor Management

Step 1: Press “ Key” to open the Acer eColor Management OSD and access the scenario modes

Step 2: Press “<” or “>” to select the mode

Step 3: Press “Auto Key” to confirm the mode and run Auto Adjust

Features and Benefits

Mode	Features	Benefits
Standard	Default settings	Reflects native display capability
Text	Optimal balance of brightness and contrast prevents eyestrain	The most comfortable way to read onscreen text
Graphics	Enhances colors and emphasizes fine detail	Pictures and photographs appear in vibrant colors with sharp detail
Movie	Displays scenes in clearest detail	Presents great visuals, even in unsuitably-lit environments
User	User defined	Settings can be fine-tuned to suit any situation

TROUBLESHOOTING

Before sending your LCD monitor for servicing, please check the troubleshooting list below to see if you can self-diagnose the problem.

(VGA Mode)

Problems	Current Status	Remedy
No Picture	LED ON	<ul style="list-style-type: none"> Using OSD, adjust brightness and contrast to maximum or reset to their default settings.
	LED OFF	<ul style="list-style-type: none"> Check the power switch.
		<ul style="list-style-type: none"> Check if AC power cord is properly connected to the monitor.
LED displays amber color		<ul style="list-style-type: none"> Check if video signal cable is properly connected at the back of monitor.
		<ul style="list-style-type: none"> Check if the power of computer system is ON.
Abnormal Picture	Unstable Picture	<ul style="list-style-type: none"> Check if the specification of graphics adapter and monitor is in compliance which may be causing the input signal frequency mismatch.
	Display is missing, center shift, or too small or too large in display size	<ul style="list-style-type: none"> Using OSD, adjust RESOLUTION, CLOCK, CLOCK-PHASE, H-POSITION and VPOSITION with non-standard signals.
		<ul style="list-style-type: none"> Using OSD, in case of missing full-screen image, please select other resolution or other vertical refresh timing.
		<ul style="list-style-type: none"> Wait for a few seconds after adjusting the size of the image before changing or disconnecting the signal cable or powering OFF the monitor.

(DVI Mode)

Problems	Current Status	Remedy
No Picture	LED ON	<ul style="list-style-type: none"> Using OSD, adjust brightness and contrast to maximum or reset to their default settings.
	LED OFF	<ul style="list-style-type: none"> Check the power switch.
		<ul style="list-style-type: none"> Check if AC power cord is properly connected to the monitor.
LED displays amber color		<ul style="list-style-type: none"> Check if video signal cable is properly connected at the back of monitor.
		<ul style="list-style-type: none"> Check if the power of computer system is ON.

**ENERGY STAR®**

Acer's ENERGY STAR qualified products save you money by reducing energy costs and helps protect the environment without sacrificing features or performance. Acer is proud to offer our customers products with the ENERGY STAR mark.

What is ENERGY STAR?

Products that are ENERGY STAR qualified use less energy and prevent greenhouse gas emissions by meeting strict energy efficiency guidelines set by the U.S. Environmental Protection Agency. Acer is committed to offer products and services worldwide that help customers save money, conserve energy and improve the quality of our environment. The more energy we can save through energy efficiency, the more we reduce greenhouse gases and the risks of climate change. More information refers to <http://www.energystar.gov> or <http://www.energystar.gov/powermanagement>

Acer ENERGY STAR qualified products:

- Produce less heat and reduce cooling loads, and warmer climates.
- Automatically go into "display sleep" and "computer sleep" mode after 15 and 30 minute of inactivity respectively.
- Wake the monitor when it is in Active Off mode, move the mouse or press any keyboard key.
- Computers will save more than 80% energy at "sleep" mode.

ENERGY STAR and the ENERGY STAR mark are registered U.S. marks



Note: The statement above is applicable only to Acer LCD Monitor with an ENERGY STAR logo.

This product has been shipped enabled for power management:

- Activate display' Sleep mode within 15 minutes of user inactivity.
- Activate computer's Sleep mode within 30 minutes of user inactivity.
- Wake the computer from Sleep mode by pushing power button.



Declaration of Conformity

We,

Acer Incorporated

8F, 88, Sec. 1, Hsin Tai Wu Rd., Hsichih, Taipei Hsien 221, Taiwan

Contact Person: Mr. Easy Lai

Tel: 886-2-8691-3089 Fax: 886-2-8691-3120

E-mail: easy_lai@acer.com.tw

Hereby declare that:

Product: 23"W LCD Monitor
Trade Name: Acer
Model Number: T230H
SKU Number: T230H xxx ("x" = 0~9, a ~ z, A ~ Z or Blank)

Is compliant with the essential requirements and other relevant provisions of the following EC directives, and that all the necessary steps have been taken and are in force to assure that production units of the same product will continue comply with the requirements.

EMC Directive 2004/108/EC as attested by conformity with the following harmonized standards:

- EN55022:2006, AS/NZS CISPR22:2006, Class B
- EN55024:1998 + A1:2001 + A2:2003
- EN61000-3-2:2006, Class D
- EN61000-3-3:1995 + A1:2001+A2: 2005

Low Voltage Directive 2006/95/EC as attested by conformity with the following harmonized standard:

- EN60950-1:2001 + A11:2004

RoHS Directive 2002/95/EC on the Restriction of the Use of certain Hazardous Substances in Electrical and Electronic Equipment

Year to begin affixing CE marking 2009.



Easy Lai /Manager
Regulation, Acer Inc.

Aug. 10, 2009
Date



Acer America Corporation
333 West San Carlos St., San Jose
CA 95110, U. S. A.
Tel : 254-298-4000
Fax : 254-298-4147
www.acer.com



Federal Communications Commission Declaration of Conformity

This device complies with Part 15 of the FCC Rules. Operation is subject to the following two conditions: (1) this device may not cause harmful interference, and (2) this device must accept any interference received, including interference that may cause undesired operation.

The following local Manufacturer /Importer is responsible for this declaration:

Product:	23"W LCD Monitor
Model Number:	T230H
SKU Number:	T230H xxx ("x" = 0~9, a ~ z, or A ~ Z)
Name of Responsible Party:	Acer America Corporation
Address of Responsible Party:	333 West San Carlos St. San Jose, CA 95110 U. S. A.
Contact Person:	Acer Representative
Phone No.:	254-298-4000
Fax No.:	254-298-4147